



New KPI's for planning microwave and millimetre wave backhaul network

Disclaimer

The present document has been produced and approved by the millimetre Wave Transmission (mWT) ETSI Industry Specification Group (ISG) and represents the views of those members who participated in this ISG. It does not necessarily represent the views of the entire ETSI membership.

Reference

DGR/mWT-0028

Keywords

backhaul, microwave, millimetre wave

ETSI

650 Route des Lucioles
F-06921 Sophia Antipolis Cedex - FRANCE

Tel.: +33 4 92 94 42 00 Fax: +33 4 93 65 47 16

Siret N° 348 623 562 00017 - APE 7112B
Association à but non lucratif enregistrée à la
Sous-Préfecture de Grasse (06) N° w061004871

Important notice

The present document can be downloaded from:

<https://www.etsi.org/standards-search>

The present document may be made available in electronic versions and/or in print. The content of any electronic and/or print versions of the present document shall not be modified without the prior written authorization of ETSI. In case of any existing or perceived difference in contents between such versions and/or in print, the prevailing version of an ETSI deliverable is the one made publicly available in PDF format at www.etsi.org/deliver.

Users of the present document should be aware that the document may be subject to revision or change of status.

Information on the current status of this and other ETSI documents is available at

<https://portal.etsi.org/TB/ETSIDeliverableStatus.aspx>

If you find errors in the present document, please send your comment to one of the following services:

<https://portal.etsi.org/People/CommitteeSupportStaff.aspx>

If you find a security vulnerability in the present document, please report it through our
Coordinated Vulnerability Disclosure Program:

<https://www.etsi.org/standards/coordinated-vulnerability-disclosure>

Notice of disclaimer & limitation of liability

The information provided in the present deliverable is directed solely to professionals who have the appropriate degree of experience to understand and interpret its content in accordance with generally accepted engineering or other professional standard and applicable regulations.

No recommendation as to products and services or vendors is made or should be implied.

No representation or warranty is made that this deliverable is technically accurate or sufficient or conforms to any law and/or governmental rule and/or regulation and further, no representation or warranty is made of merchantability or fitness for any particular purpose or against infringement of intellectual property rights.

In no event shall ETSI be held liable for loss of profits or any other incidental or consequential damages.

Any software contained in this deliverable is provided "AS IS" with no warranties, express or implied, including but not limited to, the warranties of merchantability, fitness for a particular purpose and non-infringement of intellectual property rights and ETSI shall not be held liable in any event for any damages whatsoever (including, without limitation, damages for loss of profits, business interruption, loss of information, or any other pecuniary loss) arising out of or related to the use of or inability to use the software.

Copyright Notification

No part may be reproduced or utilized in any form or by any means, electronic or mechanical, including photocopying and microfilm except as authorized by written permission of ETSI.

The content of the PDF version shall not be modified without the written authorization of ETSI.

The copyright and the foregoing restriction extend to reproduction in all media.

© ETSI 2023.
All rights reserved.

Contents

Intellectual Property Rights	5
Foreword.....	5
Modal verbs terminology.....	5
Executive summary	5
Introduction	6
1 Scope	8
2 References	8
2.1 Normative references	8
2.2 Informative references.....	9
3 Definition of terms, symbols and abbreviations.....	10
3.1 Terms.....	10
3.2 Symbols.....	10
3.3 Abbreviations	10
4 RAN traffic and MW/mmW backhaul	11
4.1 Statistical approach baseline.....	11
4.2 RAN traffic: behaviour and performances	11
4.3 MW/mmW backhaul capacity: behaviour and performances.....	13
4.4 RAN traffic and MW/mmW backhaul capacity relationship: mathematical description	15
5 MW/mmW backhaul planning according to current KPIs	17
5.1 Two check points planning approach	17
5.2 PIR check point analysis	18
5.3 CIR check point analysis.....	18
6 BTA is the new KPI to evaluate data traffic availability.....	19
7 User Experience dependency on BTA	21
7.1 Simulations goal	21
7.2 E-Band link backhauling one 5G NR site: VR, Cloud Gaming and FTP services	21
7.3 BCA link backhauling three 5G NR sites: HD Video and Web browsing services	22
7.4 Simulations summary.....	22
8 BTA benefits on wireless backhaul evolution.....	23
8.1 BTA sensitivity on traffic load and hop length	23
8.2 BTA target setting for link dimensioning.....	26
8.3 BTA to monitor new technologies operation	27
8.4 Measuring BTA in live networks	28
9 General framework for using BTA jointly with existing KPI's.....	29
9.1 Towards "Three Check Points" planning method.....	29
9.2 BTA assuring RAN traffic is not congested	29
9.3 PIR to manage data traffic burstiness	30
9.4 CIR to guarantee very high-priority services.....	32
9.5 Three check points summary.....	34
9.6 RAN traffic PDF network measures.....	35
10 BTA dependencies and impacts on most relevant related aspects	38
10.1 BTA adoption has few minor dependencies.....	38
10.2 Network planning	38
10.3 Equipment standards	39
10.4 Spectrum regulations and licensing.....	39
Annex A: BTA concept extension from single link to multi hop link topologies.....	41
Annex B: User Experience vs BTA - simulations details.....	43

B.1	E-Band link backhauling one 5G NR site: VR, gaming and FTP services	43
B.1.0	Introduction	43
B.1.1	Simulation Models and Assumptions	43
B.1.1.0	Network scenario and network simulator	43
B.1.1.1	Virtual Reality Downlink (VR DL) Stream Model.....	44
B.1.1.2	Cloud Gaming Downlink (CG DL) Stream Model.....	45
B.1.1.3	File Transfer Protocol Downlink (FTP DL) Stream Model.....	45
B.1.1.4	The Happy User	45
B.1.2	Numerical Analysis	46
B.1.2.0	Simulation results and methodology.....	46
B.1.2.1	100 % Of RAN Wireless Users Running Virtual Reality Downlink Services.....	48
B.1.2.2	100 % Of RAN Wireless Users Running Cloud Gaming Downlink Services	51
B.1.2.3	Mixed Traffic (67 % VR DL Users + 33 % FTP DL Users)	53
B.2	BCA link backhauling three 5G NR sites: HD Video and Web browsing services	55
B.2.0	Introduction	55
B.2.1	Simulation Models and Assumptions	55
B.2.1.0	Network scenario	55
B.2.1.1	Details of RAN	56
B.2.1.2	Details of wireless backhaul link	56
B.2.1.3	Combined RAN and backhaul operation	56
B.2.2	Numerical analysis	58
B.2.3	Conclusions	62
Annex C:	Change History	63
	History	64

Intellectual Property Rights

Essential patents

IPRs essential or potentially essential to normative deliverables may have been declared to ETSI. The declarations pertaining to these essential IPRs, if any, are publicly available for **ETSI members and non-members**, and can be found in ETSI SR 000 314: "*Intellectual Property Rights (IPRs); Essential, or potentially Essential, IPRs notified to ETSI in respect of ETSI standards*", which is available from the ETSI Secretariat. Latest updates are available on the ETSI Web server (<https://ipr.etsi.org/>).

Pursuant to the ETSI Directives including the ETSI IPR Policy, no investigation regarding the essentiality of IPRs, including IPR searches, has been carried out by ETSI. No guarantee can be given as to the existence of other IPRs not referenced in ETSI SR 000 314 (or the updates on the ETSI Web server) which are, or may be, or may become, essential to the present document.

Trademarks

The present document may include trademarks and/or tradenames which are asserted and/or registered by their owners. ETSI claims no ownership of these except for any which are indicated as being the property of ETSI, and conveys no right to use or reproduce any trademark and/or tradename. Mention of those trademarks in the present document does not constitute an endorsement by ETSI of products, services or organizations associated with those trademarks.

DECT™, **PLUGTESTS™**, **UMTS™** and the ETSI logo are trademarks of ETSI registered for the benefit of its Members. **3GPP™** and **LTE™** are trademarks of ETSI registered for the benefit of its Members and of the 3GPP Organizational Partners. **oneM2M™** logo is a trademark of ETSI registered for the benefit of its Members and of the oneM2M Partners. **GSM®** and the GSM logo are trademarks registered and owned by the GSM Association.

Foreword

This Group Report (GR) has been produced by ETSI Industry Specification Group (ISG) millimetre Wave Transmission (mWT).

Modal verbs terminology

In the present document "**should**", "**should not**", "**may**", "**need not**", "**will**", "**will not**", "**can**" and "**cannot**" are to be interpreted as described in clause 3.2 of the [ETSI Drafting Rules](#) (Verbal forms for the expression of provisions).

"**must**" and "**must not**" are **NOT** allowed in ETSI deliverables except when used in direct citation.

Executive summary

The ever increasing 4G and 5G traffic demand has reached a level that MW/mmW wireless backhaul extra cost due to link over-engineering is not affordable any more in terms of spectrum resources (license fees), size of antennas to be deployed, products to be used and energy consumption.

The well-known link dimensioning approach adopted today is based on two KPIs: Committed Information Rate (CIR) and Peak Information Rate (PIR) with relevant target availability derived from legacy networks. This methodology is not considering the fact that 99 % of the backhaul traffic nowadays is data.

The present document defines a new KPI called Backhaul Traffic Availability (BTA) that is based on the statistical nature of Radio Access Network (RAN) data traffic and the statistical behaviour of wireless backhaul link capacity against propagation related fading (such as rain fading). BTA represents the probability that wireless backhaul link is not congesting RAN traffic.

The present deliverable provides network simulation results demonstrating that BTA levels above 99,7 % does not impact end user Quality of Experience. Such BTA target levels can easily be met by E-Band and BCA (Band and Carrier Aggregation) links with hop lengths much longer (almost double) than typical limits derived by link dimensioning approach used today.

Finally, the present document provides baseline for a new link dimensioning approach based on CIR, PIR and BTA, called three-check points planning method. This new approach allows more efficient spectrum utilization re-considering a less conservative definition of CIR (that is no longer calculated as percentage of PIR) and PIR targets, while using BTA to make sure that the link will be capable to deliver RAN traffic without impacting Quality of Experience.

This new methodology does not change the foundation of radio propagation, it does not require new features on MW/mmW equipment and it is not changing the way spectrum is used. It only needs a simple additional module in the link planning tool for BTA calculation.

Introduction

Mobile backhaul with Microwave (MW) radio links is dating back to early 90s of last century when Mobile Network Operators (MNOs) started deploying 2G networks for voice services. 2G backhaul was a simple E1 (2 Mbps) TDM interface that was transported over PDH MW links using one single static modulation. Therefore, MNOs started to plan backhaul links based on link outage targets (derived by Recommendation ITU-T G.827, [i.1]) that were mapping one to one with voice service outage.

Since those days MNOs have deployed 3G, 4G and now 5G Radio Access Networks (RAN) introducing data services on top of voice services: this took place with an exponential growth of backhaul capacity demand that is summarized within following picture (more details on 5G capacity demand can be found in [i.2]). In a nutshell, it has started with 2 Mbps for 2G, and with 5G launch there is a need for 2 Gbps (and beyond): this is 3 orders of magnitude capacity growth.

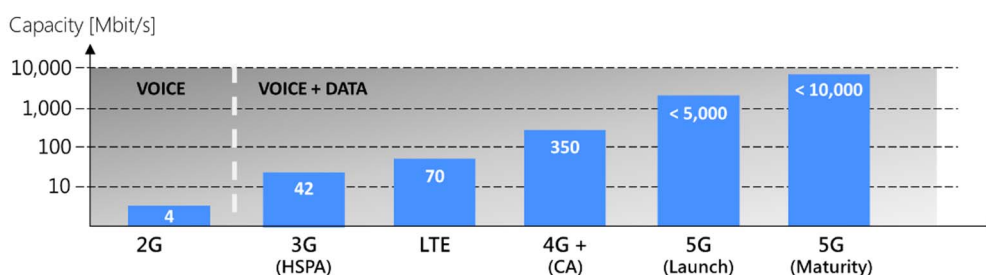

Figure 1: Backhaul capacity growth along RAN technology generations

In order to cope with an exponential backhaul capacity growth, MW technologies evolved introducing three key steps to make most efficient usage of spectrum resources:

- Adaptive Coding and Modulation (ACM): for increasing spectral efficiency without compromising on link outage.
- E-Band millimetre Wave (mmW) usage: for leveraging huge free spectrum on short hops.
- Band and Carrier Aggregation (BCA): for increasing E-Band applicability on longer hops without compromising on link outage.

All these MW and mmW technologies introduced a wide dynamic range of capacity and availability pairs on top of the simple TDM concept of link availability (outage) that was used for 2G. These new technologies have been deployed by MNOs worldwide using planning availability criteria and targets derived by TDM consolidated concepts. Generally speaking, large majority of MNOs adopted the following approach:

- link availability target was kept unchanged (4 to 5 nines typically) and a minimum target link capacity or committed information rate (CIR) was defined based on a variety of criteria;

- maximum link capacity or Peak Information Rate (PIR) target was defined based on RAN technology deployed using simple formulas (most famous ones come from NGMN [i.3]) and setting a "less conservative availability target" (4 nines, 3 nines, 2 nines) without strong rationales.

Regardless of which formulae and target availabilities MNOs choose to adopt, none of them can be considered a proper planning methodology because they are missing to take into account two key aspects:

- RAN traffic cannot be described using only two figures (minimum and maximum, translated into CIR and PIR); traffic demand is a continuous set of values (from min to max) with certain occurrence probabilities;
- MW/mmW backhaul link impact on RAN traffic demand cannot be described by two availability targets (those associated with CIR and PIR) because it depends on full set of capacity and availability pairs provided by ACM and BCA technologies.

The present document aims at defining a new planning methodology that will be based on the two key aspects listed above. As the established planning methodology is based on some KPIs (CIR, PIR and relevant availability targets) there is the need to define a new KPI in order to have a measurable parameter that can be calculated during link design phase and then monitored in the network.

Reasons triggering the need of a new planning methodology is that existing one can lead to:

- either a link over-engineering in case of too demanding availability targets (e.g. when setting 4 nines on PIR);
- or a link under-engineering in case of reduced capacity targets (e.g. a PIR that does not suit RAN traffic peak burstiness).

This fact is true since 3G era when MNOs started delivering data services. Nowadays with 4G and 5G traffic demand levels, the Total Cost of Ownership (TCO) impact due to link over-engineering is becoming bigger and bigger in terms of spectrum resources (license fees), size of antennas to be deployed, products to be used, etc. In other words, MNOs deserve a more suitable planning methodology in order to optimize MW/mmW backhaul links TCO.

At the same time, this new planning methodology will ensure MNOs that MW/mmW backhaul links are properly serving RAN traffic without impacting network performances, overall network KPIs and finally the User Experience (most important aspect).

1 Scope

The present document is aiming at the definition of new KPI's for planning microwave and millimetre wave backhaul networks. Identification of new KPI's should take into account the evolution of wireless backhaul:

- more challenging requirements coming from 5G deployment;
- new technologies aiming at more efficient interference mitigation and cancellation;
- increase of use of spectrum in the millimetre wave range, both stand-alone and aggregated (BCA);
- different typologies and mix of services transported.

User Experience is the key driver for backhaul dimensioning considered in the present document. Studies, carried out to produce the present document, have considered RAN traffic characteristics (both network measures and full (propagation, interference, multi users, scheduling and protocols) RAN simulations) in conjunction with backhaul link behaviour against propagation related fading (e.g. rain fading, multipath fading, etc.), with the aim to reach the most efficient backhaul spectrum usage and reduced Total Cost of Ownership (TCO).

The present document focuses primarily on "single backhaul link" (carrying one or multiple RAN site(s) traffic) that is baseline for MW/mmW planning. A few preliminary considerations on link daisy chains (legacy MW topology), hubs & spoke (on-going topology trend due to increasing fibre penetration) and more general geographic area approaches (i.e. clusters of hubs) can be found in annex A.

The present document considers RAN downlink traffic since it is more demanding than uplink traffic, thus becoming the backhaul link dimensioning constraint in case of FDD symmetric spectrum resources allocation (standard approach for all MW and mmW bands used for mobile backhaul today).

The present document is considering links already deployed and links that will be deployed using consolidated MW/mmW technology (such as ACM and BCA). However in the present document the reader will also find some general considerations on emerging MW/mmW technology evolutions.

The present document also provides an analysis of impacts and dependencies of the new KPI's on:

- network planning and monitoring (across entire link life cycle in a network);
- equipment standards (to spot if there are impacts or dependencies);
- spectrum regulations and licensing (to spot if there are impacts or dependencies).

Finally, it is also worth mentioning that Fronthaul (definition in 3GPP TR 38.801 [i.4]) is out of the present document scope, while mid-haul can be considered included in the scope of the present document because it has capacity & latency requirements very similar with backhaul ones. Regarding backhaul link, the present document focus is on propagation related fading and it does not consider end users experience impacts due to any other backhaul link impairments such as equipment failures, energy outage and network operations.

2 References

2.1 Normative references

Normative references are not applicable in the present document.

2.2 Informative references

References are either specific (identified by date of publication and/or edition number or version number) or non-specific. For specific references, only the cited version applies. For non-specific references, the latest version of the referenced document (including any amendments) applies.

NOTE: While any hyperlinks included in this clause were valid at the time of publication, ETSI cannot guarantee their long term validity.

The following referenced documents are not necessary for the application of the present document but they assist the user with regard to a particular subject area.

- [i.1] Recommendation ITU-T G.827 (September 2003): "Availability performance parameters and objectives for end-to-end international constant bit-rate digital paths".
- [i.2] ETSI White Paper No. 25 (February 2018): "Microwave and Millimetre-wave for 5G Transport".
- [i.3] NGMN 0.4.2 FINAL (July 2011): "Guidelines for LTE Backhaul Traffic Estimation".
- [i.4] 3GPP TR 38.801 (V14.0.0): "3rd Generation Partnership Project; Technical Specification Group Radio Access Network; Study on new radio access technology: Radio access architecture and interfaces (Release 14)".
- [i.5] Recommendation ITU-R P.530-18 (September 2021): "Propagation data and prediction methods required for the design of terrestrial line-of-sight systems".
- [i.6] Recommendation ITU-R P.837-7 (June 2017): "Characteristics of precipitation for propagation modelling".
- [i.7] ETSI GR mWT 016 (V1.1.1): "Applications and use cases of Software Defined Networking (SDN) as related to microwave and millimetre wave transmission".
- [i.8] ETSI EN 302 217-1 (all parts): "Fixed Radio Systems; Characteristics and requirements for point-to-point equipment and antennas".
- [i.9] Recommendation ITU-R F.1703-0 (2005): "Availability objectives for real digital fixed wireless links used in 27500 km hypothetical reference paths and connections".
- [i.10] Recommendation ITU-R F.2113-0 (January 2018): "Error performance and availability objectives and requirements for real point-to-point packet-based radio links".
- [i.11] ETSI TS 138 300: "5G; NR; Overall description; Stage-2 (3GPP TS 38.300 Release 15)".
- [i.12] ETSI TR 138 901 (V15.0.0): "5G; Study on channel model for frequencies from 0.5 to 100 GHz (3GPP TR 38.901 version 15.0.0 Release 15)".
- [i.13] 3GPP TR 38.838 (V17.0.0): "Study on XR (Extended Reality) Evaluations for NR".
- [i.14] 3GPP TR 36.814 (V9.2.0): "Further advancements for E-UTRA physical layer aspects".
- [i.15] 3GPP TR 36.873 (V12.7.0): "Study on 3D channel model for LTE".
- [i.16] Recommendation ITU-T P.1203 (October 2017): "Parametric bitstream-based quality assessment of progressive download and adaptive audiovisual streaming services over reliable transport".

3 Definition of terms, symbols and abbreviations

3.1 Terms

For the purposes of the present document, the following terms apply:

dimensioning (a link): activity carried out by MNO to calculate link system gain needed to meet all link capacity requirements

NOTE: Along the present document (link) planning or design is used as synonymous of (link) dimensioning

E1: European format for digital transmission of one PCM signal 2 048 kbit/s

end user experience (quality of experience): service quality perceived by a human being using a mobile terminal

mode: combination of a modulation order and a Forward Error Correction (FEC) coding scheme that a link can operate

propagation related fading: any possible fading due to propagation phenomena (such as rain or multipath) considered in Recommendation ITU-R P.530-18 [i.5]

3.2 Symbols

For the purposes of the present document, the following symbols apply:

c_i	Link capacity value corresponding to a given link mode ($i=0,1,\dots,N$)
$P_o(c_i)$	Outage probability corresponding to a given link mode ($i=0,1,\dots,N$)

3.3 Abbreviations

For the purposes of the present document, the following abbreviations apply:

2G	2 nd Generation Mobile Networks
3G	3 rd Generation Mobile Networks
4G	4 th Generation Mobile Networks
5G NR	5G New Radio
5G	5 th Generation Mobile Networks
ACM	Adaptive Coding and Modulation
BCA	Band and Carrier Aggregation
BTA	Backhaul Traffic Availability
CA	Carrier Aggregation
CDF	Cumulative Distribution Function
CG	Cloud Gaming
CIR	Committed Information Rate
DL	Down Link
E2E	End to End
FDD	Frequency Division Duplex
FEC	Forward Error Correction
FTP	File Transfer Protocol
FWA	Fixed Wireless Access
GBR	Guaranteed Bit Rate
gNB	5G Node B
HD	High Definition
IP	Internet Protocol
KPI	Key Performance Indicator
LTE	Long Term Evolution
MIMO	Multiple Input Multiple Output
mmW	millimetre Wave
MNO	Mobile Network Operator
MU	Multiple Users

MW	MicroWave
NGMN	Next Generation Mobile Networks alliance
NMS	Network Management System
OSI	Open Systems Interconnection
PDB	Packet Delay Budget
PDF	Probability Density Function
PDH	Plesiochronous Digital Hierarchy
PIR	Peak Information Rate
PM	Performance Monitoring
POP	Point Of Presence
QoE	Quality of Experience
QoS	Quality of Service
RAN	Radio Access Network
RAT	Radio Access Technology
RBS	Radio Base Station
RS	Radio Site
SDN	Software Defined Network
SLA	Service Level Agreement
SU	Single User
SyncE	Synchronous Ethernet
TCO	Total Cost of Ownership
TCP	Transmission Control Protocol
TDD	Time Division Duplex
TDM	Time Division Multiplex
UE	User Equipment
UL	Up Link
uR	ultra-Reliable
VR	Virtual Reality
WCDMA	Wide band Code Division Multiple Access
XPIC	Cross Polar Interference Canceller
XR	eXtended Reality

4 RAN traffic and MW/mmW backhaul

4.1 Statistical approach baseline

The present clause provides the mathematical baseline used to prepare the present document by defining:

- RAN traffic as a statistical random variable (T) determined by several factors such as service types, end users' number, end users' device performances, end users' geo-distribution across cell coverage, Radio Access network Technologies (RATs) deployed, radio access network design in terms of coverage, interference, etc.;
- MW/mmW backhaul link capacity as a statistical random variable (C) determined by rain fading and further possible propagation impairments (e.g. multipath fading, etc.), as per consolidated Recommendation ITU-R P.530-18 [i.5];
- a mathematical description of the relationship between these two statistical variables (RAN traffic and MW/mmW backhaul link capacity).

4.2 RAN traffic: behaviour and performances

RAN traffic generated by a single RAN cell (sector) with a single RAT is determined by several factors such as:

- end users' number served by the cell (this is continuously changing since it is a mobile network);
- end user's geo-distribution across cell coverage (given a certain number of users, overall cell traffic depends on whether users are under good or bad propagation conditions);

- end users' habits and services (traffic volume and traffic patterns changes a lot if users are doing web browsing on public transportation or using FWA service at home watching 4k videos);
- radio access network design in terms of coverage and interference (changing with RAT configurations and RAT features like SU-MIMO, MU-MIMO, CA, etc.);
- RAT parameters setting (changing continuously with optimization algorithms in place nowadays);
- end users' device performances (e.g. 4G/5G User Equipment Category 1, 2, to 26, etc.) that can leverage existing network resources to a certain level;
- etc.

It is worth noting, in the present document, that **RAN traffic is considered the amount of throughput potentially generated by a certain configuration of the radio access network** (in terms of the features specified above) **without taking into account possible bottlenecks imposed by the backhaul layer**. This definition, that dissociates the behaviour of the backhaul links from the actual traffic requests characterizing (in a statistical sense) the peculiar radio access scenario, will allow defining a new planning method for MW/mmWave backhaul systems that is fully oriented to the real End Users Experience.

All the above variables are impacting RAN traffic generated also in the simplest considered scenario (single RAN cell with a single RAT) that can only be described as a statistical random variable.

When considering the traffic generated by one RAN site, typically composed of 3 cells (sectors) and a combination of some RAT layers (4G + 5G across multiple bands), it can only be described with a statistical variable.

Then, when considering traffic generated by a certain number of RAN sites, once again it can only be described with a statistical variable.

By observing this statistical variable in a live network for a certain period of time, the resulting traffic pattern looks similar to the example shown in Figure 2: there is huge difference between minimum (low traffic hours) and maximum (busy hours traffic) and there is a certain periodicity along days and weeks.

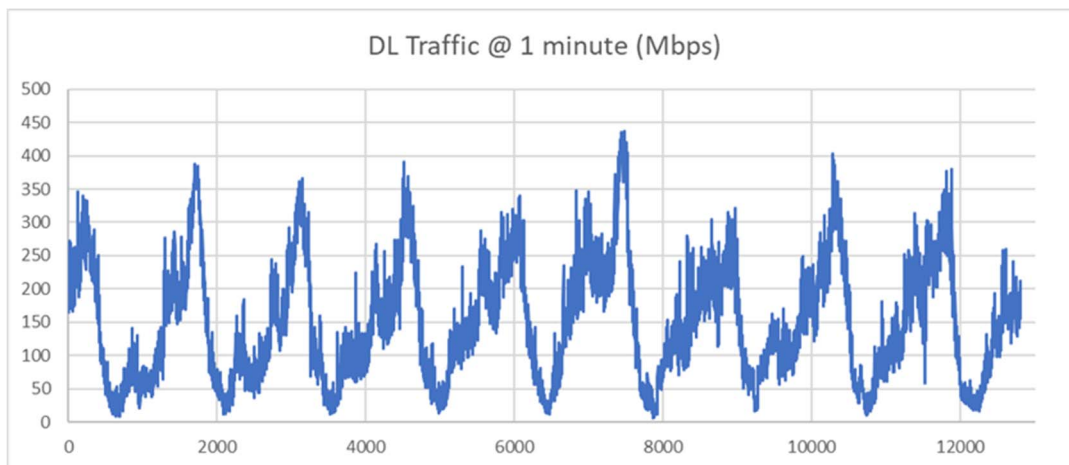

Figure 2: RAN traffic pattern example during 10 days

Traffic patterns are completely different in the case of a 4G+5G RAN site (using 150 MHz spectrum overall) in dense urban areas or in the case of a 4G RAN site (using 20 MHz spectrum) in rural areas, and this is quite obvious. What is less obvious is that different RAN sites with same set of RAT layers and spectrum usage, even when deployed within the same urban area, can have completely different traffic patterns due to the different number of users served during different time of the day. Moreover, even observing the same RAN site during 7 consecutive days and overlapping traffic patterns along the 24 hours, the typical outcome is very different daily patterns as depicted in Figure 3.

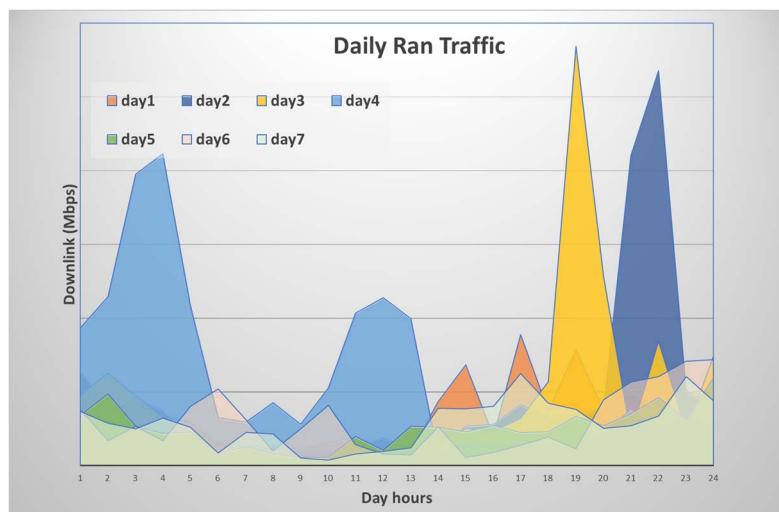

Figure 3: RAN site daily traffic patterns for 7 consecutive days

Therefore, it is not possible describing RAN traffic behaviour with simple formulae, see [i.3], that calculate some few theoretical RAN performance figures (peak, average, etc.) based on the number and type of RAT layers deployed. The only viable approach is to consider RAN traffic as a statistical random variable (T) that can be described by its own Probability Density Function (PDF) or Cumulative Distribution Function (CDF) as depicted in Figure 4. The traffic PDF shape for a given RAN site will change from one day to another and, of course, it will shift to the right along years while the overall end users throughput grows (see Figure 4 b).

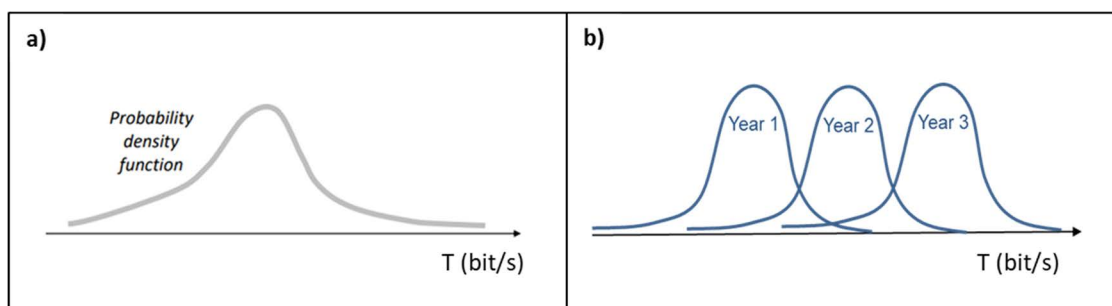

Figure 4: RAN site traffic PDF ($RAN_{PDF}(T)$) (a) and its evolution along years with traffic growth (b)

From previous considerations (see Figure 2 and Figure 3), it is evident that RAN traffic (T) is not a stationary process, in the sense that PDF, average, variance, etc. change over time. Therefore, the first question link planners can have is the following: which PDF should be considered? The answer is the following: most appropriate PDF can be identified according to actual needs. If it is for link planning purposes, it might be useful considering worst case traffic PDF measured over the network for all RAN sites with same RAT set-up. If it is for link monitoring purposes, it might be useful considering daily traffic pattern envelope across multiple days (see Figure 3), considering max value at any time and then calculating PDF.

One final remark is that, the only PDF (CDF) curve is sufficient to provide the overall RAN traffic description as it represents the amount of bits per unit of time, with the associated occurrence probabilities, that should be delivered by the backhaul network including the MW/mmW backhaul link serving the RAN, along hours, days, weeks, months and years.

4.3 MW/mmW backhaul capacity: behaviour and performances

MW/mmW backhaul link capacity (C) behaviour is characterized by:

- a minimum link capacity (usually identified as CIR) that can be delivered even with very deep propagation related fading before the link goes on full outage (when connectivity is down - zero traffic delivered for few minutes in a year in this case);

- a maximum link capacity (usually identified as PIR) that can be provided in clear sky conditions for most of the time in a year (usually more than 364 days in a year);
- a set of intermediate link capacities that can be provided (by ACM and BCA technologies) in between clear sky and deep propagation related fading conditions, usually referred as graceful capacity degradation, lasting for few hours in a year- as depicted in Figure 5.

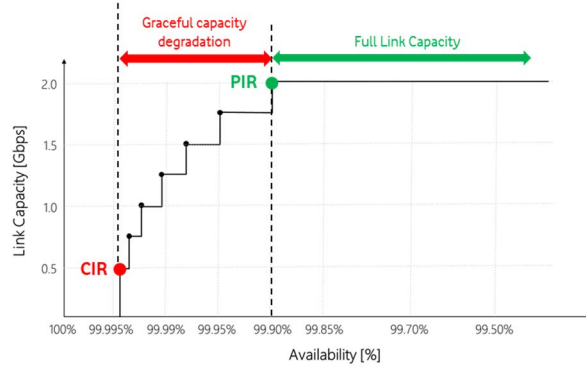

Figure 5: MW/mmW backhaul link capacity behaviour against propagation related fading events

Backhaul MW capacity provided by a link using ACM and BCA is a statistical random variable determined by:

- link design (system gain, bands, antennas, etc.);
- propagation impairments (mostly rain fading).

That does not have any periodicity, since capacity drops are taking place during some fading events randomly spread along the year, each one with different time duration and fading depth.

The time duration in which the backhaul link is providing a certain capacity level (c_i) is calculated as a probability of fading occurrence according to well established ITU-R prediction methods provided in Recommendation ITU-T P.530-18 [i.5]. This means that also MW/mmW link capacity performance can be described with a statistical random variable C that can only assume a discrete set of values $\{c_i\}_{i=1}^N$. Notice that each capacity value c_i can be associated with a certain outage probability $P_o(c_i)$ ($i = 1, 2, \dots, N$) as described in Figure 6. Accordingly the probability density function of MW/mmW backhaul link capacity C can be formulated in a continuous domain as (see Figure 6):

$$\Pr(C) = P_o(c_1) \cdot \delta(C) + \sum_{i=1}^{N-1} [P_o(c_{i+1}) - P_o(c_i)] \cdot \delta(C - c_i) + [1 - P_o(c_N)] \cdot \delta(C - c_N)$$

where $\delta(C)$ is the Dirac delta function.

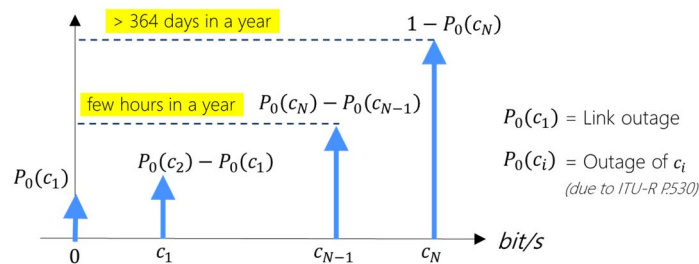

Figure 6: Statistical description of the MW/mmW backhaul link capacity

The set of pairs $(c_i, P_o(c_i))$ is what MW/mmW link planning tools calculate today with consolidated Recommendation ITU-R P.530-18 [i.5] prediction methods. MW/mmW planning methodologies adopted by MNOs today typically consider only a couple of these pairs, usually the two pairs $(c_1, P_o(c_1))$ and $(c_N, P_o(c_N))$.

4.4 RAN traffic and MW/mmW backhaul capacity relationship: mathematical description

In the previous clauses of clause 4, it has been described that both RAN traffic and MW/mmW backhaul capacity can be described with statistical random variables determined by:

- RAN network characteristics and users' behaviour for RAN traffic (T);
- propagation related fading events (or other possible adverse propagation conditions as outlined in Recommendation ITU-R P.530-18 [i.5]) for MW/mmW backhaul capacity (C).

Since there are no common factors determining RAN traffic and MW/mmW backhaul capacity, **these two random variables can be considered statistically independent** and therefore their joint probability density function is the product of the two probability density functions described previously in this clause. This is baseline to understand the mathematical relationship provided in this clause.

$$\Pr(T, C) = RAN_{PDF}(T) \cdot \left\{ P_o(c_1) \cdot \delta(C) + \sum_{i=1}^{N-1} [P_o(c_{i+1}) - P_o(c_i)] \cdot \delta(C - c_i) + [1 - P_o(c_N)] \cdot \delta(C - c_N) \right\}$$

$$\Pr(T, C) = P_o(c_1) \cdot \delta(C) \cdot RAN_{PDF}(T) + \sum_{i=1}^{N-1} [P_o(c_{i+1}) - P_o(c_i)] \cdot \delta(C - c_i) \cdot RAN_{PDF}(T) + [1 - P_o(c_N)] \cdot \delta(C - c_N) \cdot RAN_{PDF}(T)$$

Given a RAN site traffic PDF ($RAN_{PDF}(T)$) as per clause 4.2) and a MW/mmW backhaul link capacity PDF (as per clause 4.3) it is possible representing the joint probability density function formula $\Pr(T, C)$ as depicted in Figure 7, showing in a 3D representation:

- the set of N blue curves replicating the shape of RAN traffic PDF ($RAN_{PDF}(T)$);
- for different MW/mmW backhaul link capacities ($0, c_1, c_2$ and c_N) weighted by relevant availabilities ($P_o(c_1), (P_o(c_2) - P_o(c_1)) \dots$ and $1 - P_o(c_N)$).

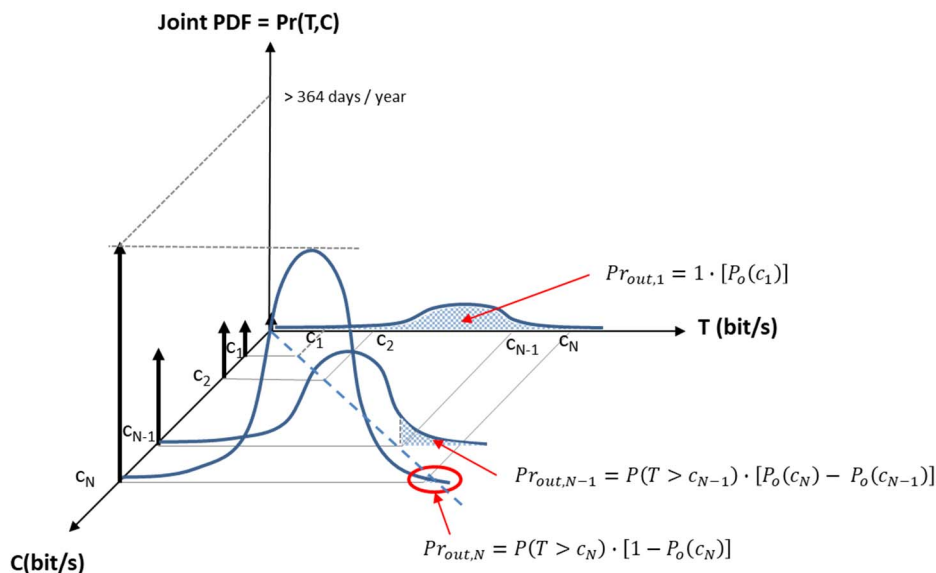

Figure 7: Joint probability density function and probability of RAN traffic exceeding backhaul capacity

Given a RAN site traffic PDF (as per clause 4.2) and a MW/mmW backhaul link capacity PDF (as per clause 4.3), it is possible to calculate the probability that the MW/mmW backhaul link cannot deliver the entire RAN traffic demand by using the joint probability density function depicted in Figure 7. Areas coloured in blue represent the probability that RAN traffic (T) is exceeding MW/mmW backhaul capacity c_i ($i = 1, 2, \dots, N$), **AND** that the MW/mmWave backhaul link is delivering a capacity equal to c_i , due to the specific propagation conditions experienced on field (e.g. rain fading or other according to Recommendation ITU-T P.530 [i.5]):

- when it is clear sky (with probability $1 - P_o(c_N)$), only RAN traffic exceeding maximum MW/mmW backhaul capacity c_N cannot be delivered by MW/mmW backhaul link, and the overall probability of this sub-event reads:

$$Pr_{out,N} = P(T > c_N) \cdot [1 - P_o(c_N)]$$

Notice that $P(T > c_N)$ is the complementary cumulative distribution function of the random variable T evaluated in c_N ($CCDF_T(c_N)$), and can be derived as:

$$P(T > c_N) = CCDF_T(c_N) = \int_{c_N}^{+\infty} RAN_{PDF}(T) dT$$

- when there is light propagation related fading and MW/mmW backhaul capacity is c_{N-1} (with probability $P_o(c_N) - P_o(c_{N-1})$), only RAN traffic exceeding c_{N-1} cannot be delivered by the MW/mmW backhaul link; the overall probability of this sub-event reads:

$$Pr_{out,N-1} = P(T > c_{N-1}) \cdot [P_o(c_N) - P_o(c_{N-1})]$$

- and so on for intermediate periods when MW/mmW backhaul capacity suffers a graceful degradation ($c_{N-2}, c_{N-3}, \dots, c_1$) due to increasing propagation related fading strengths (these contributions are not depicted in Figure 7);
- and also including any RAN traffic (probability equal to 1) that will be lost in case of MW/mmW backhaul link full outage (with probability $P_o(c_1)$), with the overall probability of this sub-event reads:

$$Pr_{out,1} = 1 \cdot [P_o(c_1)]$$

The overall probability that the MW/mmW backhaul link cannot deliver all RAN traffic demand can be derived by summing up the contributions above as:

$$Pr_{out} = P(T > c_N) \cdot [1 - P_o(c_N)] + P(T > c_{N-1}) \cdot [P_o(c_N) - P_o(c_{N-1})] + \dots + 1 \cdot [P_o(c_1)]$$

By doing simple math (regrouping formula contributions according to MW/mmW backhaul links capacity outages), it is straightforward getting the following expression for overall probability that the MW/mmW backhaul link cannot deliver all RAN traffic demand:

$$Pr_{out} = P(T > c_N) \cdot [1 - P_o(c_N)] + P(T > c_{N-1}) \cdot [P_o(c_N) - P_o(c_{N-1})] + \dots + P(T > c_1) \cdot [P_o(c_2) - P_o(c_1)] + 1 \cdot [P_o(c_1)]$$

$$Pr_{out} = P(T > c_N) + [P(T > c_{N-1}) - P(T > c_N)] \cdot P_o(c_N) + \dots + [1 - P(T > c_1)] \cdot P_o(c_1)$$

A B C

Notice that, in the above expression, each term $[P(T > c_{k-1}) - P(T > c_k)]$ expresses the probability that the RAN traffic lies within the interval (c_{k-1}, c_k) . The different contributions (A, B, ... and C) can be visualized as per Figure 8 with different colours (red, green, ... and amber). This latter mathematical expression will be used for the following clauses of the present document because it is more convenient to understand analysis and outcomes of the present document, and it is reported in the following in compact form for the sake of clearness.

$$Pr_{out} = P(T > c_N) + [P(T > c_{N-1}) - P(T > c_N)] \cdot P_o(c_N) + \dots + [1 - P(T > c_1)] \cdot P_o(c_1)$$

$$= [1 - P(T > c_1)] \cdot P_o(c_1) + \sum_{i=2}^N [P(T > c_{i-1}) - P(T > c_i)] \cdot P_o(c_i) + P(T > c_N)$$

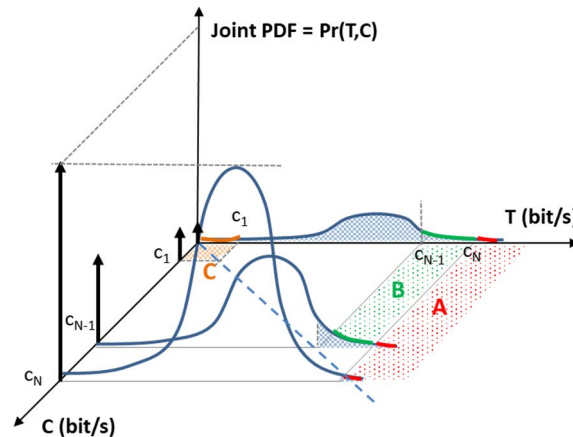

Figure 8: Joint probability density function and probability of RAN traffic exceeding backhaul capacity

One key remark is worth after all the above probability theory and maths: **Pr_{out}** represent the probability for **MW/mmW backhaul link being unable to deliver the entire amount of RAN traffic demand during propagation related fading events**. This means that during all these events (except during full link outage occurring with probability $P_o(c_1)$) a certain portion of RAN traffic is still delivered; in other words there will be some end users experience impacts (due to MW/mmW backhaul) but **end user services will be still up and running with quality of experience managed by Mobile Network components (RAN + Core + Transport) as well as End to End (Client to Server application on the Internet) by L4 (e.g. TCP/IP) to L7 layers of the OSI protocol stack**.

5 MW/mmW backhaul planning according to current KPIs

5.1 Two check points planning approach

Before starting to identify new KPI's for planning microwave and millimetre wave backhaul networks it is mandatory analysing what is today current planning approach and what are its weaknesses and limitations. Based on mathematical description provided within clause 4, it is possible running this analysis for well-established CIR + PIR (**two check-points**) planning approach, already mentioned in the present document introduction.

The two check-points approach can be summarized as follows for a backhaul link connecting one radio site:

- 1) PIR is calculated (e.g. using NGMN formulae [i.3]) considering the mix of RAT layers and amount of spectrum deployed in the radio site.
- 2) PIR is used to define maximum link capacity c_N (usually c_N is slightly greater than PIR because actual link capacity is set by spectrum channel granularity).
- 3) **Link is dimensioned in order to reach a certain availability (typically in the range 99,9 % - 99,99 %) at PIR (c_N).**
- 4) CIR is then derived by PIR with rule of thumbs (e.g. 10 % of PIR) or it is set with other criteria (e.g. 100 Mbps for a 4G radio site with a certain spectrum usage).

- 5) CIR is used to define minimum link capacity c_1 (usually c_1 is slightly greater than CIR because actual link capacity is set by spectrum channel granularity).
- 6) **Link is dimensioned in order to reach a certain availability (typically in the range 99,995% - 99,999%) at CIR (c_1).**
- 7) The more stringent of the two check-points (steps 3) and 6) in bold above) dictates the link dimensioning in terms of band, channel size, modulations, transmitted power and antennas size to be used, given the hop length and rain rate adopted for link planning.

In the following clauses 5.2 and 5.3 dimensioning criteria will be analysed for the two check points approach.

5.2 PIR check point analysis

When dimensioning a backhaul link, PIR is the maximum peak traffic that RAN site can generate, considering traffic evolution in coming years in order to be future proof. Figure 9 shows an example of RAN traffic PDF (that this radio site could be generating along years) together with PIR calculated as per methodology of step 1) in clause 5.1: depending on the formula adopted for PIR calculation there is a wide range of PIR values associated to a certain mix of RAT layers and spectrum deployed in the RAN site.

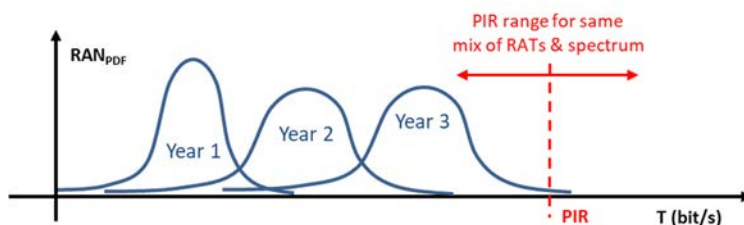

Figure 9: RAN traffic PDF evolution vs PIR

Beside the fact that PIR could become traffic limiting factor only when radio site will start to be congested in future (e.g. Year 3 in Figure 9) - reaching the limit of RAT layers considered for PIR calculations - it is important to point out the following questions:

- PIR might be never impacting RAN traffic (e.g. if PIR is calculated as the sum of peaks across all RAT layers); therefore, what is the need to get such a high PIR availability?
- In case RAN traffic in busy hours will exceed PIR (e.g. when PIR is the sum of RATs/cells average traffic with overbooking factors), what is the backhaul impact on end user experience having set PIR availability at 4 or 3 or 2 nines?
- Moreover, when RAN traffic is not exceeding PIR (e.g. Year 1 and 2 in the above picture) what is the backhaul link impact on end user experience considering that backhaul link capacity graceful degradation (e.g. during rain fading events) is forbidding to deliver RAN traffic for 365 days in a year?

These three questions do not have answers with current dimensioning approach, and this is its weakness. Reason of this weakness is that current approach does not consider two facts: RAN traffic is a random variable (that cannot be described with one single figure such as PIR) and backhaul link capacity is another statistical distribution (that cannot be described with one figure $PIR_{availability}$).

This analysis can be summarized with a simple question: why requiring 99,9 % for a peak rate that is demanded by the RAN with a very small probability (0,1 %) or never demanded at all?

5.3 CIR check point analysis

Definition of CIR is even more disconnected from data traffic delivery and user experience. In fact, it used to represent the amount of voice traffic (few E1's per radio site) when MW/mmW backhaul moved from TDM to IP (during 3G era) and it was always associated to minimum link capacity (c_1) that is delivered with voice services availability (typically in the range 99,995 % to 99,999 %).

When overall data traffic increased (with 4G), the CIR figure started to change its meaning and to follow the evolution of PIR as shown in Figure 10, while maintaining the same old target availability (4 to 5 nines).

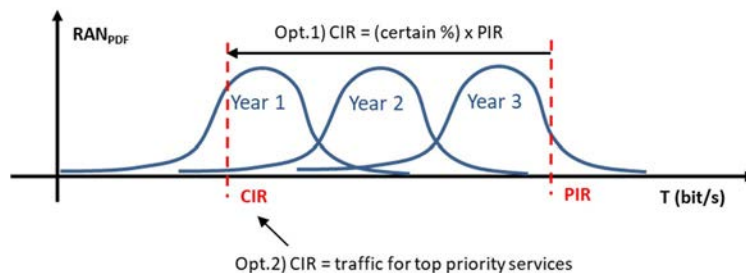

Figure 10: RAN traffic PDF evolution vs CIR

Major weakness related to CIR is that data services do not behave as voice services with a "hard stop" when backhaul capacity goes below the E1 capacity: data services will suffer a continuous performance degradation starting when capacity is well above CIR and continuing also when capacity goes below CIR; and this degradation is managed by QoS mechanisms as well as at application level. These facts lead to the following questions that do not have an answer with existing planning approach:

- What is the amount of "top priority" services that should be associated with CIR?
- What is the effect on overall user experience by setting CIR availability at 4 or 5 (or any other number of) nines?

Finally, the remark here is the same applicable to PIR, there are no answers to questions above for the simple reason that current dimensioning approach does not take into account two facts: RAN traffic is a random variable (that cannot be described with one single figure such as CIR) and backhaul link capacity is another statistical distribution (that cannot be described with one figure CIR_{availability}).

This analysis can be summarized with a simple question: what is the value of guaranteeing 5 nines to 10 % to 20 % of PIR (that is several hundreds of Mbps in case of 5G network) for best effort data traffic? Is the MNO over engineering the microwave network with minor benefits on end user experience?

6 BTA is the new KPI to evaluate data traffic availability

With the purpose to go beyond limitations of two check-points approach (CIR + PIR) analysed in clause 5, it is necessary to introduce a new KPI related to the probability of MW/mmW backhaul link to deliver (or discard) RAN traffic. As per mathematical background provided in clause 4, it is worth considering:

$$Pr_{out} = [1 - P(T > c_1)] \cdot P_o(c_1) + \sum_{i=2}^N [P(T > c_{i-1}) - P(T > c_i)] \cdot P_o(c_i) + P(T > c_N)$$

that is the probability for MW/mmW backhaul link being unable to deliver the entire RAN traffic demand, e.g. due to propagation related fading events. Therefore it is possible defining a new KPI, called **Backhaul Traffic Availability (BTA)**, as follows:

$$BTA = 1 - Pr_{out}$$

representing the probability that the MW/mmW backhaul link is capable to deliver 100 % of the RAN traffic demand, therefore having no impacts on End User Experience.

In order to start getting familiar with this new KPI, it is worth visualizing (see Figure 11) the formula on two dimensional chart (derived by 3D pictures presented in clause 4) and analysing various contributions:

- A is the probability that RAN traffic exceeds link PIR (c_N);

- B is the probability that RAN traffic is in between c_{N-1} and c_N while c_N is in outage (due to propagation related fading);
- all other intermediate contributions express the probability that RAN traffic is in between c_{i-1} and c_i while c_i is on outage (due to propagation related fading);
- C is the probability that RAN traffic is lower than c_1 (CIR) while c_1 is in outage (due to propagation related fading).

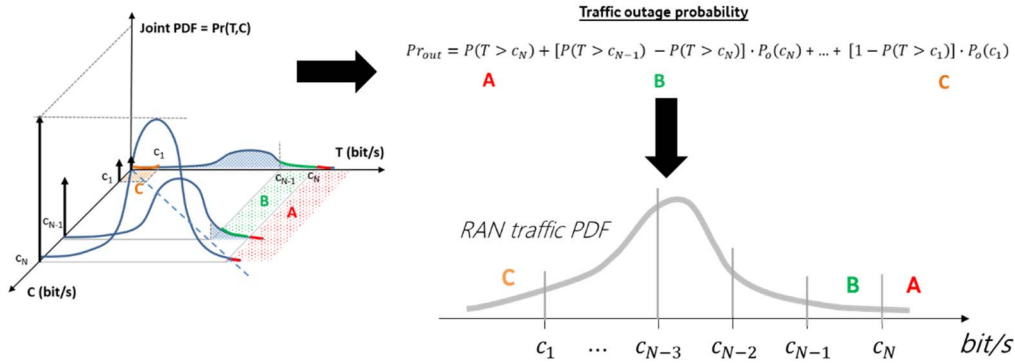

Figure 11: BTA formula contributions

Considering, as an example, a link designed with RAN traffic never exceeding PIR, contribution A will be null while most significant contributions $B_n, B_{n-1},$ etc. can be represented as per Figure 12:

$$BTA = 1 - Pr_{out} = 1 - [B_n + B_{n-1} + B_{n-2} + B_{n-3} + \dots B_j + C]$$

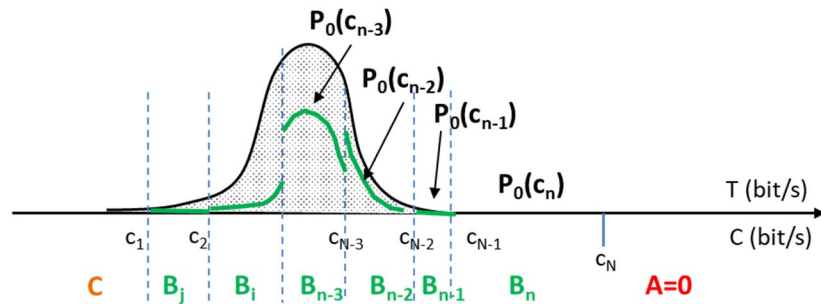

Figure 12: BTA most significant contributions (green lines) consisting in the probability density function that is multiplied by the different outage probabilities

Considering the example of RAN traffic PDF depicted in Figure 12 it is evident that:

- B_n will be zero because RAN traffic does not exceed c_{N-1} ;
- B_{n-1} will be a negligible contribution because RAN traffic exceeds c_{N-2} with little probability (RAN traffic PDF is almost flat on x-axis between c_{N-2} and c_{N-1});
- B_{n-2} will be the first significant contribution because RAN traffic exceeds c_{N-3} for large amount of time;
- B_{n-3} is also a significant contributor to BTA;
- B_i and B_j are smaller contributors because of RAN traffic PDF decreasing and because $Po(c_{n-4}), Po(c_{n-5}),$ etc. are lower than $Po(c_{n-3})$;
- C is the contribution due to link outage, negligible due to the fact that $Po(c_1)$ is very small.

In other words; BTA is determined by the set of backhaul link capacity outages weighted by RAN traffic probabilities:

- the higher the RAN traffic (PDF curve shifting to the right), the more important become high capacity link outage contributions ($Po(c_n)$, $Po(c_{n-1})$, $Po(c_{n-2})$, etc.) and the lower becomes the BTA (for a certain fixed link);
- the lower the RAN traffic (PDF curve shifting to the left), the more important become low capacity link outage contributions ($Po(c_1)$, $Po(c_2)$, $Po(c_3)$, etc.) and the higher becomes the BTA (for a certain fixed link).

BTA is a unique KPI fully describing MW/mmW backhaul link capability to deliver a certain RAN traffic profile, once that the PDF of such statistical variable is known; in a complementary way BTA allows planning the capability to deliver RAN traffic across different PDF scenarios (that depends on site configurations, traffic load, expected capacity growth, etc.).

In a nutshell, BTA is the pivotal KPI linking RAN traffic demand (i.e. end user experience) with MW/mmW backhaul link capacity (and propagation related fading degradations), closing the gap in the existing two check-points planning approach described in clause 5.

7 User Experience dependency on BTA

7.1 Simulations goal

In clause 7 provides key outcomes of 5G RAN and backhaul traffic simulations carried out with the purpose to evaluate the impacts of limited backhaul capacity (measured in terms of BTA) on End User Quality of Experience (QoE) defined according to 3GPP and ITU documents. Details of such simulations (scenarios, simulation models and assumptions, services description and QoE metrics) can be found in annex B.

The goal for these simulations is to evaluate if the End User Quality of Experience has a huge or little dependency on backhaul link BTA figure. Simulations consider an E-Band link (clause 7.2) and a BCA (18 GHz + E-Band) link (clause 7.3) that represent most suitable 5G wireless backhaul solutions. Both sets of simulations are at system-level, based on fully-fledged 5G RAN simulators plugged with extra modules to simulate a wireless backhaul link. All simulations focus on downlink direction that is the more traffic demanding in terms of wireless backhaul link dimensioning. The two set of simulations adopt a variety of standardized (3GPP and ITU-T) methodologies to evaluate QoE.

7.2 E-Band link backhauling one 5G NR site: VR, Cloud Gaming and FTP services

This set of simulations (details in clause B.1) consider Virtual Reality (VR), Cloud Gaming (CG) and FTP services: simulations refer to scenarios with 100 % traffic from one service type (VR or CG) as well as with some service type mix (VR and FTP). **Traffic generation for all scenarios is based on 3GPP models.**

RAN section simulates a three sectors 5G site using 100 MHz channel at 3,5 GHz according to 3GPP models.

Wireless backhaul section simulates an **E-Band link** using 250 MHz channel: BTA of such link is stressed with different hop lengths from zero (ideal backhaul) up to 7 (4) km on regions with rainfall rate of 60 (145) mm/h.

The End User Quality of Experience is measured by the number (percentage) of happy users: a user is considered happy if a target % of the received packets undergo an overall delay lower than an application-specific target **Packet Delay Budget** (PDB).

For each service scenario different simulation runs are carried out with different number of users (generating traffic level up to RAN channel congestion) and different wireless backhaul link capacities (according to ACM of E-Band link). With a numerical analysis it is possible to calculate the average percentage of happy users against a certain RAN traffic load (that is the RAN traffic PDF discussed in previous clauses).

By stressing wireless backhaul link with an increasing hop length (with a lower BTA) the average percentage of happy users decreases. All scenarios simulated show that:

- average percentage of happy users is determined by RAN channel congestions, even with an ideal backhaul link of 0 km (BTA = 100 %) this number is always well below 100 % (typically in the range 50 to 90 % depending on service type and RAN load);
- wireless backhaul link introduces a negligible **decrease of average percentage of happy users (less than 0,1 percentage points)** even with hop lengths up to 4 to 7 km (depending on rainfall rate) **with BTA down to 99,9 %**.

7.3 BCA link backhauling three 5G NR sites: HD Video and Web browsing services

This set of simulations (details in clause B.2) consider HD video streaming and web browsing services: simulations refer to scenarios with mixed traffic from these two services. **Traffic patterns per users and per service type are taken from realistic user behaviour.**

RAN section simulates three 5G sites (each one with 3 sectors) using 100 MHz channel at 3,5 GHz according to 3GPP models. The traffic of the three sites is ideally collected (fibre with infinite capacity) into a single site and then backhauled with one wireless link.

Wireless backhaul section simulates a 6,92 km **BCA link using 56 MHz in the 18 GHz band and 750 MHz in the E-Band** in a region with rainfall rate of 35 mm/h: BTA of such link is stressed by changing transmit power of the E-Band link while the 18 GHz carrier is always using maximum transmitted power.

The End User Quality of Experience is measured on [1 to 5] scoring scale: video stream service scoring is determined according to Recommendation ITU-T P.1203 [i.16] while web browsing service scoring is determined by the time to download 2 MB file (scoring 1 if exceeding 3 seconds). A QoE scoring of 5 represents an excellent QoE, while 1 represents a poor QoE.

Three different RAN traffic loads (22 %, 52 %, 76 %) are simulated by changing the number of users. The post-processing numerical analysis consists on applying a static link configuration (with certain E-Band transmit power) to a steady RAN traffic load (either 22 % or 52 % or 76 %) and measuring the average QoE.

By stressing wireless backhaul link with a decreasing E-Band transmit power (with a lower availability of all ACM capacities) the average QoE decreases. All scenarios simulated show that:

- even with ideal backhaul (100 % availability of infinite capacity) the average QoE is below 5 (going down to 4,5 with high traffic load of 76 %) due to RAN limitations, such as interference, resource sharing between multiple users and poor user channel quality due to propagation effects;
- average QoE decrease **less than 0,01** (within scoring scale 1 to 5, that is **0,2 % drop**) in case of limited wireless backhaul provided that **BTA is higher than 99,7 %** (for any RAN load and any service type).

7.4 Simulations summary

The two set of simulations summarized in clauses 7.2 and 7.3 consider different set of services (scenarios), use different ways for traffic generation, use different simulation tools and adopt different criteria to measure Quality of Experience.

Beside all these differences and some worst-case assumptions taken for simplifying simulations, the outcomes are the same and can be summarized as follows:

- **Quality of Experience (of RAN users) is mainly affected by the RAN channel impairments and congestions.**
- Quality of Experience (of RAN users) changes a lot depending on RAN traffic load.
- When RAN traffic load is low/medium the wireless backhaul link is not affecting Quality of Experience (of RAN users).

- When RAN traffic load is high the radio propagation impairments on **wireless backhaul link results in a negligible 0,1 to 0,2 % Quality of Experience** (of RAN users) **degradation as long as BTA is in the range 99,7 % to 99,9 %**.

8 BTA benefits on wireless backhaul evolution

8.1 BTA sensitivity on traffic load and hop length

Since the new KPI BTA depends on RAN traffic statistical distribution, and such distribution can assume a wide range of shapes as discussed in clause 4, it is convenient to use a general purpose cumulative distribution function in order to carry out BTA sensitivity analysis. In particular, the family of the cumulative distribution functions of the beta distribution (referred to in the following as beta cumulative distribution functions for a more concise notation) is used because it can describe a wide range of cumulative distribution function shapes (based on the choice of parameters a, b) and because for any traffic live network measure analysed by ISG mWT, it was possible identifying a corresponding beta cumulative distribution function. Figure 13 provides a snapshot of several beta Cumulative Distribution Functions (CDF) for a radio site that can generate traffic up to $t_{max}=7$ Gbps, with different choices of parameters (a, b).

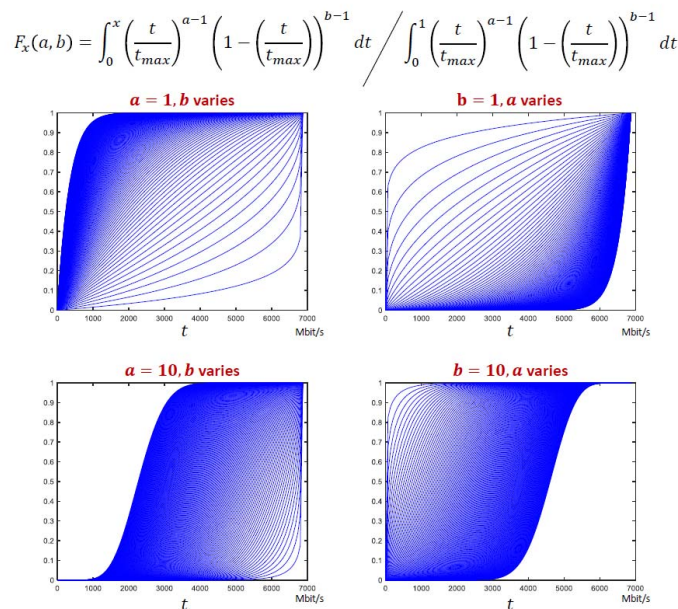

Figure 13: beta cumulative distribution function can describe any RAN traffic CDF shape

As a first example of BTA sensitivity it is possible analysing and E-Band link deployed over 2 km hop length, using 500 MHz XPIC (to deliver a peak capacity of almost 7 Gbps) with 60 cm antennas and typical system gain characteristics: the availability of various link capacities (ACM) can be calculated for rain rate region of 42 mm/h as shown in Table 1.

Table 1: 2 km E-Band link capacities availability for various ACM

E-band 500 MHz Dual Pol, 60 cm antennas (42 mm/h)								
762 Mbit/s	1526 Mbit/s	2289 Mbit/s	3053 Mbit/s	3817 Mbit/s	4580 Mbit/s	5344 Mbit/s	6108 Mbit/s	6872 Mbit/s
99,998 %	99,996 %	99,994 %	99,993 %	99,991 %	99,986 %	99,980 %	99,975 %	99,957 %

Considering this backhaul link, it is possible calculating BTA for any combination of (a, b) parameters of the beta distribution (as shown in Figure 13): results can be summarized as per Figure 14 where different coloured areas identify regions with different BTA lower bounds (99,995 % is dark blue, 99,97 % is green, etc.). The red circle marked as "3x" represents typical "peak to median ratio" of cumulative distribution functions measured over mature 4G networks: this "3x" circle tells that this **super heavy RAN traffic profile** (reaching 50 % CDF probability at 2,3 Gbps and 100 % CDF probability at 6,8 Gbps) will experience a BTA better than 99,98 % (that is much higher than 99,957 % availability corresponding to the maximum of E-Band link capacity listed in Table 1).

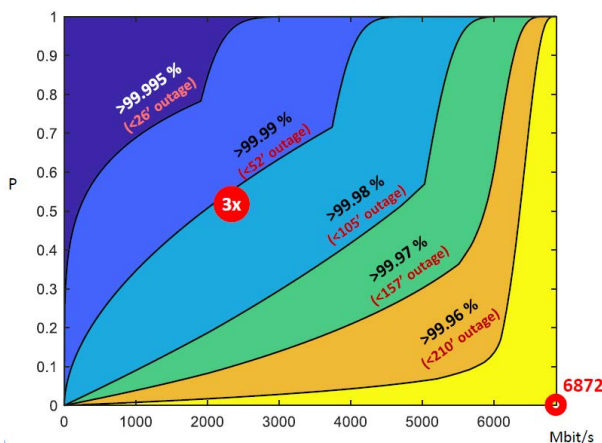

Figure 14: 2 km, 7 Gbps E-Band link BTA lower bounds chart for any beta cumulative distribution function

If the same E-Band link (same product, antennas and configuration) is instead deployed over 4 km hop length (doubling link distance compared to 2 km and reducing link capacities availability as per Table 2), the resulting BTA chart is shown in Figure 15:

- where the same RAN traffic profile as before (with peak to median ratio equal to 3) will experience a BTA of about 99,95 % (that is **0,04 percentage points worse than the 2 km hop length case**);
- regardless the fact that E-Band peak capacity availability has dropped to 99,769 % (that is **0,2 % percentage points worse than 2 km hop length case**).

Table 2: 4 km E-Band link capacities availability for various ACM

E-band 500 MHz Dual Pol, 60 cm antennas (42 mm/h)									
762 Mbit/s	1526 Mbit/s	2289 Mbit/s	3053 Mbit/s	3817 Mbit/s	4580 Mbit/s	5344 Mbit/s	6108 Mbit/s	6872 Mbit/s	
99,989 %	99,980 %	99,971 %	99,966 %	99,956 %	99,936 %	99,903 %	99,876 %	99,769 %	

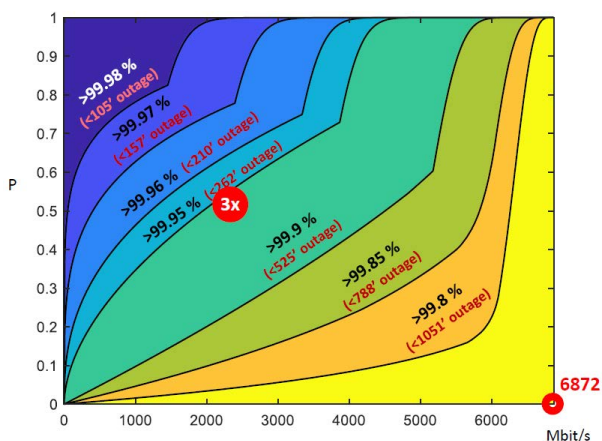

Figure 15: 4 km, 7 Gbps E-Band link BTA lower bounds chart for any beta probability distribution

Using the same analysis methodology, it is possible calculating BTA lower bounds for a BCA link using 18 GHz (56 MHz XPIC) and E-Band (500 MHz XPIC) with 60 cm antennas, deployed in the same 42 mm/h rain rate region as before with hop lengths of 7 km and 12 km. Figure 16 provides BTA charts comparison for the two hop lengths, showing **0,2 percentage points BTA degradation for 12 km hop length** (99,6 % instead of 99,8 %) if considering RAN traffic profiles with a peak-to-median ratio equal to nearly 3, regardless the fact that BCA peak capacity (see Table 3) is delivered with almost **1,6 percentage points lower availability at 12 km** (actually the two top level capacities cannot be transmitted because of lack of system gain).

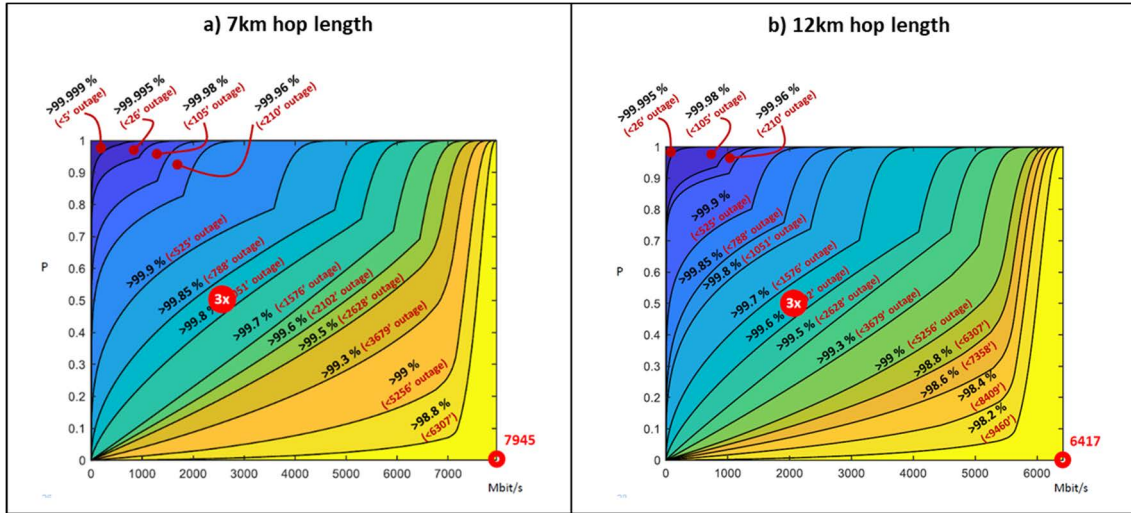

Figure 16: 7 km and 12 km BCA (18 GHz + 80 GHz) link BTA lower bounds charts for any beta cumulative distribution function

Table 3: 7 km and 12 km BCA (18 GHz + 80 GHz) link capacities availability for all ACM+BCA modes

a) 7km hop length		b) 12km hop length	
E-band 500 MHz H/V + 18 GHz 56 MHz H/V (42 mm/h)		E-band 500 MHz H/V + 18 GHz 56 MHz H/V (42 mm/h)	
Capacity [Mbit/s]	Availability	Capacity [Mbit/s]	Availability
179	99,999%	179	99,995%
317	99,999%	317	99,993%
360	99,999%	360	99,992%
451	99,998%	451	99,989%
575	99,997%	575	99,983%
681	99,995%	681	99,976%
787	99,992%	787	99,959%
897	99,988%	897	99,937%
981	99,978%	1659	99,887%
1743	99,962%	1743	99,870%
1835	99,953%	2507	99,802%
2599	99,935%	3270	99,703%
3362	99,907%	3362	99,639%
4126	99,887%	4126	99,629%
4890	99,854%	4890	99,493%
5653	99,777%	5653	99,119%
6417	99,634%	6417	98,098%
7181	99,497%		
7945	98,723%		

Similar sensitivity analysis can be done for links deployed with ACM and BCA across any frequency band and for any target capacity MNO can aim for backhauling 4G and 5G networks. All the evaluated scenarios suggest the same conclusion that BTA degradation against the extension of link distance is not scaling linearly with PIR availability degradation, it instead follows more the degradation of link capacities sitting in between CIR and PIR and according to the specific RAN traffic distribution.

This fact, in conjunction with End User Experience simulations results (see clause 7 and annex B) demonstrating a tiny dependency on BTA, clearly shows that MW/mmW backhaul **maximum link distances can be stretched much more than current best practices adopted by MNOs** (e.g. 2 km for a stand-alone E-Band, 7 km for BCA link with E-Band).

This means that it is possible increasing the use of spectrum in the millimetre wave range (stand-alone and aggregated BCA) with all related TCO advantages (spectrum cost and less MW/mmW radios to be deployed) and avoiding low-bands spectrum congestion risks.

8.2 BTA target setting for link dimensioning

BTA represents the probability for MW/mmW backhaul link being capable to deliver 100 % of RAN traffic (as defined in clause 6), therefore it provides the probability that backhaul link is not congesting RAN traffic. **Consequently, the complementary probability (1-BTA) represents the probability that backhaul link is congesting RAN traffic.**

BTA figures that can be reached by E-Band or BCA links (even when stretching hop distance - see clause 8.1) with very high RAN traffic is almost always higher than 99,9 % to 99,5%. This means that the probability that backhaul link is congesting RAN traffic is lower than 0,1 % to 0,5 %. RAN cells could experience traffic congestions during busy hours when too many End Users demand more traffic than the one that can be managed by all RATs deployed. Since overall network congestion probability depends on:

- [RAN cells congestions probability] due to limited RATs resources;
- [1-BTA] due to MW/mmW backhaul capacity degradation (e.g. during rain events).

The MNO can define its own BTA target by allocating a certain congestion probability (from overall network congestion probability) to MW/mmW backhaul capacity degradation as depicted in Figure 17.

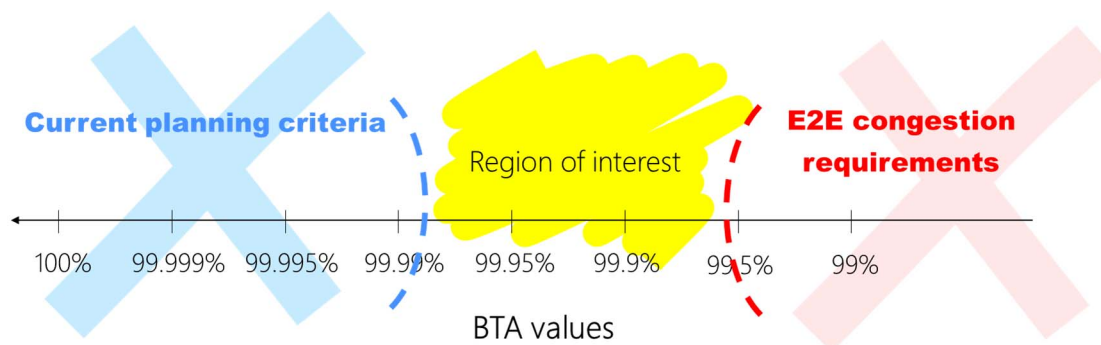

Figure 17: BTA target range with lower boundary (red area) to be derived from E2E congestion KPI target

Clause 7 simulations outcomes demonstrate that BTA target in the range 99,7 % to 99,9 % is not impacting at all End User Quality of Experience for any mix of services analysed, therefore this is another important indication that MNO can use in order to define its own BTA target.

In order to better explain this concept, it is worth analysing the case if a MNO that decides to allocate 0,5% (as an example) of network congestion probability to MW/mmW backhaul. Assuming network topology foresees only one hop from fibre POPs then BTA target will be 0,5 % for all MW/mmW links in the network. In case of different network topologies (e.g. daisy chains) with two (or more) MW/mmW hops from fibre POPs, the overall BTA target (e.g. 0,5 %) for MW/mmW network should be properly apportioned across links with some rules as described in annex A.

BTA calculation for link dimensioning depends on the assumed RAN traffic PDF as described in clause 8.1. In other words, the calculation of the BTA can only be done on a purely hypothetical basis, as it is derived from an arbitrary choice of a RAN traffic PDF curve which cannot be known a priori. The MNO will be using one of the following options for RAN traffic PDF to make sure the link is properly designed to be future proof:

- typical RAN traffic PDF of an equivalent RAN site in the network (measurements at the time when the link dimensioning takes place);
- very high RAN traffic PDF of an equivalent RAN site in the network (measurements at the time when the link dimensioning takes place);
- very high RAN traffic PDF of an equivalent RAN site in the network (projected in 2, 3, ... years in the future);

- uniform RAN traffic PDF (same traffic probability between CIR and PIR) that is always the worst case (although totally unrealistic).

This options list is just an example, others RAN traffic PDF can also be assumed by the MNO depending on future proof approach that it would like to adopt.

BTA measurement during link commissioning phase (for acceptance procedures) is of limited value because traffic passing over the link in this phase has nothing to do with RAN traffic PDF assumed for link dimensioning.

BTA measurement can be used for assessing the adequacy status of the radio link in operations. For this purpose, BTA can be measured (as described in clause 8.4) and it can be calculated by means of a traffic PDF estimation derived from the MW/mmW link (or RAN itself) PM counters (as described in clause 9.6).

8.3 BTA to monitor new technologies operation

BTA concept, representing the probability for MW/mmW backhaul link being capable to deliver 100 % of RAN traffic (no traffic congestion), can also be used to monitor proper behaviour of new MW/mmW technologies that intentionally **reduce the maximum available link capacity for several hours a day** in order to optimize other network KPI's (e.g. energy consumption, shared spectrum usage, etc.). When such technologies are deployed the MNO should have a KPI to assess if the RAN traffic is accidentally impacted (not delivered / congested) **because the link operates at low capacity for percentages of time comparable (or higher) with RAN cells congestion probability**. BTA is the target KPI to be used for this purpose and it can be used both in the planning phase (when designing / configuring the new technology) and during network operation (to monitor BTA KPI).

It is worth explaining the above concept using the example of a new technology called "Efficient power consumption" (SDN capability described in ETSI GR mWT 016 [i.7]). Energy saving is one major goal of both current and future networks. In addition to specific power-saving mechanisms that can be embedded into equipment hardware, more sophisticated mechanisms and their activation can be controlled by a centralized application, based on deep data analysis from historical and current network configurations and load conditions.

Such mechanisms can include activation/deactivation of carriers in multi-carrier systems (BCA). As an example, it is worth considering a high power long haul link made of 4 carriers. Each carrier consumes around 50 Watts; overall the 4 carriers consume about 200 Watts. In the case that during night-time capacity drops to ¼ of the peak, 150 Watts can be saved. With a traffic profile that looks like Table 4, a power saving in the order of 36 % can be achieved every day.

Table 4

Time of Day	Amount of traffic versus peak
5:00 to 8:00	50 %
8:00 to 10:00	75 %
10:00 to 16:00	100 %
16:00 to 20:00	75 %
20:00 to 24:00	50 %
24:00 to 5:00	25 %
Daily Average	63,54 %

This is a suitable example of new MW/mmW technologies coming-up into mobile backhaul networks leveraging low traffic periods when a subset of transmission resources is sufficient to deliver expected RAN traffic. However, it is well known (as explained in clause 4) that RAN traffic cannot be predicted with 100 % accuracy and therefore there is residual (small) probability to experience short periods of high traffic even during predicted low traffic periods: that means residual risk to lose RAN traffic and creating traffic congestions.

BTA can first assist the MNO in the design and configuration of "Efficient power consumption" technology as follows:

- BTA due to propagation related fading is calculated as per clause 6; assuming $1-BTA_{rain} = 0,1 \%$ as an example.
- In order to keep overall BTA negligible vs RAN cells congestion (as described in clause 8.2) the MNO could set BTA target due to "Efficient power consumption" (BTA_{epc}) same value as rain BTA, that is $1-BTA_{rain} = 1-BTA_{epc} = 0,1 \%$.

- This 0,1 % becomes upper boundary for residual risk to lose RAN traffic during "predicted low traffic periods", therefore allowing the MNO to set proper rules for defining low traffic periods, considering prediction algorithms accuracy.

Even more important is to develop a methodology that allows measuring traffic congestion periods (1-BTA) due to MW/mmW technologies; this is because it is mandatory for the MNO to compare network BTA against the planned BTA (99,8 % in the planning example described above). Some possibilities of BTA measurement methodologies are provided in clause 8.4.

What is important to remark here is that **BTA is also a useful network KPI to operate new MW/mmW technologies** such as "Efficient power consumption" or "Interference handling" (see ETSI GR mWT 016 [i.7]): in fact, it could easily happen that low accuracy traffic prediction algorithms or technology misconfigurations can lead to un-expected traffic congestions.

8.4 Measuring BTA in live networks

At first sight it seems impossible measuring periods of time when RAN traffic would be exceeding last mile backhaul capacity bottleneck if such limitation was not be in place. Actually, it is impossible trying to have a direct measurement, such as counting seconds when RAN traffic is exceeding backhaul capacity: this will never happen because of backhaul capacity bottleneck is in place.

It is instead possible measuring traffic congestion periods (that is when RAN traffic would be exceeding last mile backhaul capacity bottleneck if such limitation would not exist, i.e. 1-BTA) with indirect measurements such as:

- continuous packet drops over the link;
- latency increase over the link;
- link utilization very close to 100 %.

Continuous packet drop methodology likely requires smarter PM counters than typical ones available on existing equipment providing just number of dropped packets in 5 or 15 minutes period. This is useless granularity considering that packets drop rate is limited by TCP/IP and E2E protocols that manage backhaul limitations, therefore making difficult distinguishing between congested and not congested traffic periods.

Latency increase over the link is a PM parameter typically not available on existing equipment. It will require Time Synchronization (with accuracy in the range of 50 μ s considering that link latency can fall below 50 μ s for high capacity links) between the two terminal of the link.

Link utilization close to 100 % is a methodology that can work using existing PM counters (those providing average link utilization with 5 or 15 minutes granularity). As depicted in Figure 18 (on left hand side), it is important comparing the RAN traffic (blue curve) with actual link capacity (red curve): this last one can change from time to time depending on propagation related fading. Therefore, the simplification used for this description (steady link capacity within a 15 minute period) should be removed and taken into consideration in live networks to determine (1-BTA) measurement accuracy. Beside this consideration the concept and methodology described on Figure 18 does not change.

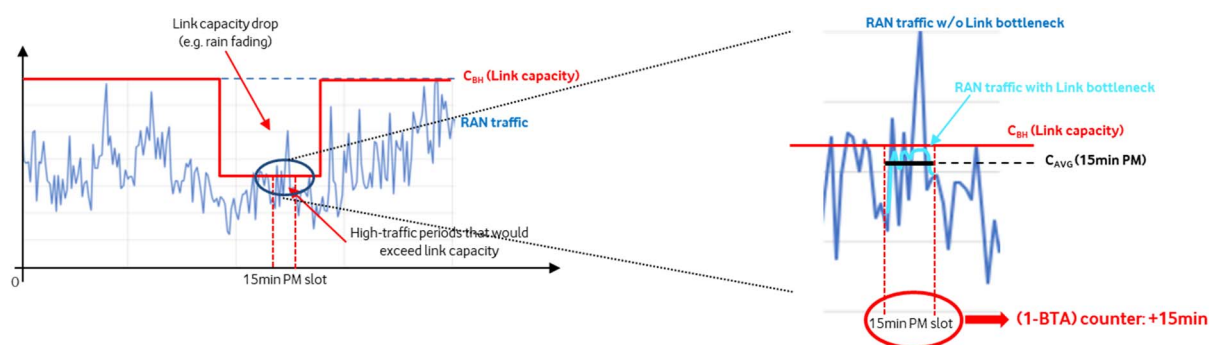

Figure 18: Traffic congestion measurement using link utilization PM counter

Figure 18 (on right hand side) is describing the methodology by showing:

- current link capacity (red line);

- the theoretical RAN traffic demand (blue line, theoretically exceeding red line);
- the actual RAN traffic (cyan line) that will be squeezed by link bottleneck and reactions of E2E protocols (e.g. TCP/IP) remaining always below the red line;
- the average link capacity usage (black line) detected by 15 minutes PM counter.

When traffic congestion is taking place the black line (C_{AVG}) will be closer to red line (C_{BH}); when these two values gap ($C_{BH} - C_{AVG}$)/ C_{BH} is below a certain value (%) the (1-BTA) counter will be incremented by 15 minutes. From some few live network measurements, it seems that when this gap is below 10 % a traffic congestion period should be counted. However, it is suggested running network measurement campaigns, eventually using different PM time granularities (15 minutes, 5 minutes, etc.), in order to identify suitable gap threshold (20 %, 10 %, 5 %, etc.) to be used for (1-BTA) periods identification.

9 General framework for using BTA jointly with existing KPI's

9.1 Towards "Three Check Points" planning method

Clause 9 provides indications on how to improve link dimensioning against propagation related fading from today best practice (two check points approach described in clause 5, based on CIR and PIR) to a new approach (three check points approach) that is including BTA on top of CIR and PIR.

Clause 9 will also address two major changes that should be introduced in the planning phase (RAN traffic PDF to be used) and during network operations (how to measure RAN traffic PDF).

9.2 BTA assuring RAN traffic is not congested

As explained in clause 8.2, BTA represents the probability for MW/mmW backhaul link being capable to deliver 100% of RAN traffic, therefore it provides the percentage of time when MW/mmW backhaul link will not create RAN traffic congestions.

As highlighted in Figure 19, BTA describes the entire MW/mmW link behaviour and its graceful capacity degradation, in particular all (availability, capacity) pairs (marked with red dots in the example below) called link "modes" for simplicity, and not only the two extreme pairs of the two check points approach described in clause 5 (based on CIR and PIR).

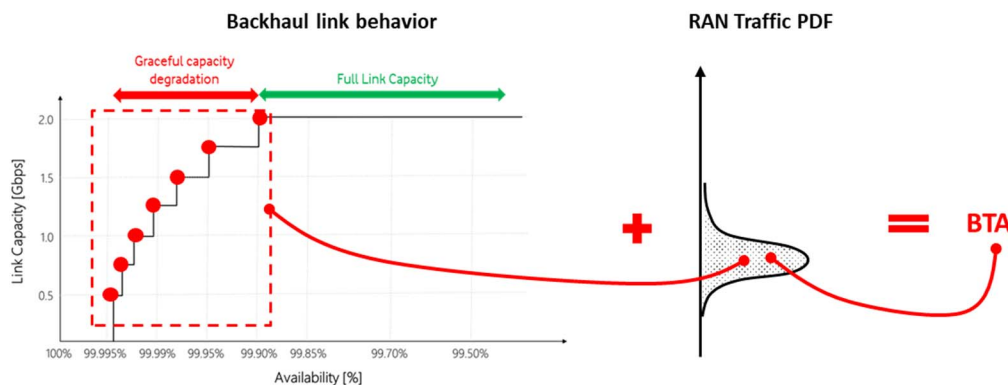

Figure 19: BTA describes entire link capacity graceful degradation against a certain RAN traffic PDF

BTA can be calculated in the design phase by using certain RAN traffic PDF that could be one of the following (examples from the following three categories are depicted in Figure 20):

- red curve: flat PDF with maximum value estimated as "busy hour RAN site capacity" (e.g. using [i.3] NGMN formulae); this is worst case providing always BTA lower boundary that can be experienced with any RAN traffic profile with the same maximum value (Max);
- blue curve: beta distribution with certain (a, b) parameters and maximum value (Max) estimated as "busy hour RAN site capacity" (e.g. using [i.3] NGMN formulae as above);
- black curve: MNO suitable models coming from its network measures (e.g. addressing different RAT layers and spectrum within RAN site, number of RAN sites backhauled, rural and urban scenarios, etc.).

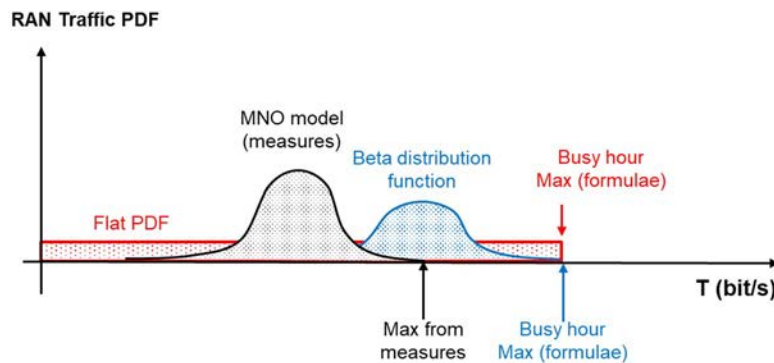

Figure 20: Example of possible RAN traffic PDF categories that can be used for BTA calculation

9.3 PIR to manage data traffic burstiness

RAN traffic PDF curves adopted for BTA calculation in clause 9.2 represent the amount of traffic to be delivered to make all End Users happy on the service quality they perceive. Since End User Quality of Experience is mostly related to human perception against service delays (e.g. the time requested to start watching a video), it is straightforward that **"time granularity" lower limit impacting user experience is in the "one second" range**. Meaning that RAN traffic PDF curves should be measured with this 1 second time granularity and BTA calculated against these curves.

On the other hand data traffic is also characterized by strong **burstiness** due to:

- proprietary protocols running in between service application (on end user device) and server (in a data centre somewhere around the world);
- MNO core network functions (e.g. policing, shaping, throttling, etc.);
- Layer 4 protocols running on top of IP networks (e.g. TCP/IP);
- policing, buffering and shaping all along MNO transport network;
- RAN scheduling algorithm to fairly serve all UEs connected.

All these (and other network specific) mechanisms act with time granularity much lower than 1 second, typically in the range 10 ms to 100 ms, in order to exploit all shared available network resources and to deliver services with best possible quality.

The result of the above considerations is the typical data burstiness observed with different time granularities for one specific service delivered to a single user. Figure 21 is an example of a video stream service over an empty 4G cell: this is extreme case of burstiness due to the fact that cell is empty and single service can take up to entire RAN cell capacity (100 Mbps). During first 10 seconds initial video caching requires about 20 Mbps, while for the rest of the streaming average traffic demand is about 3 Mbps; this is what impacts User Experience and this is what RAN traffic PDF should capture. Focusing on first 10 seconds with time granularity of 10 ms (100 ms) it is possible to observe traffic burstiness that can easily reach peaks of 80 Mbps (30 Mbps). Typical case in busy hours is characterized by much lower burstiness due to the fact that RAN cells are loaded with several users competing for the same capacity.

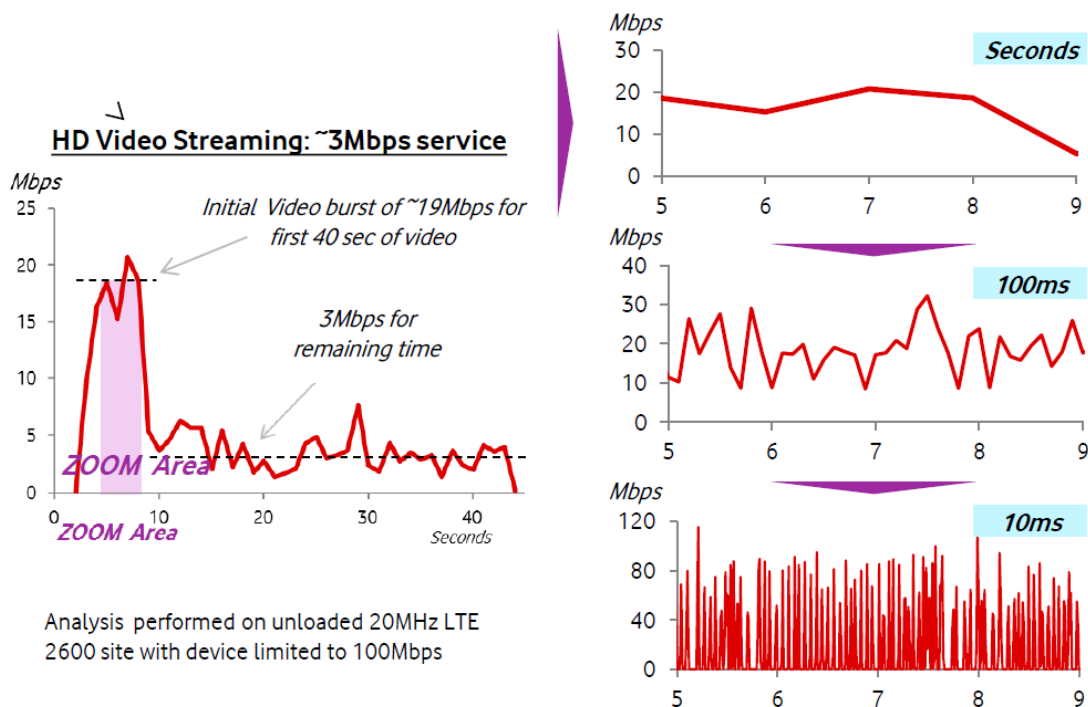

Figure 21: Typical data burstiness that can be observed with measures time granularity moving from "seconds" (RAN traffic to be delivered) down to "100 ms" and "10 ms" (data burstiness to manage)

The same data burstiness effect can also be observed across measurements carried out with different time granularities above the one second level: an example is provided in Figure 22 for a backhaul link with four different time granularities spanning from 1 second to 5 minutes. This example shows that maximum RAN traffic is below 200 Mbps when observed at 5 minutes time granularity, while it can be as high as 250 Mbps (and more) if it is observed at 1 second time granularity.

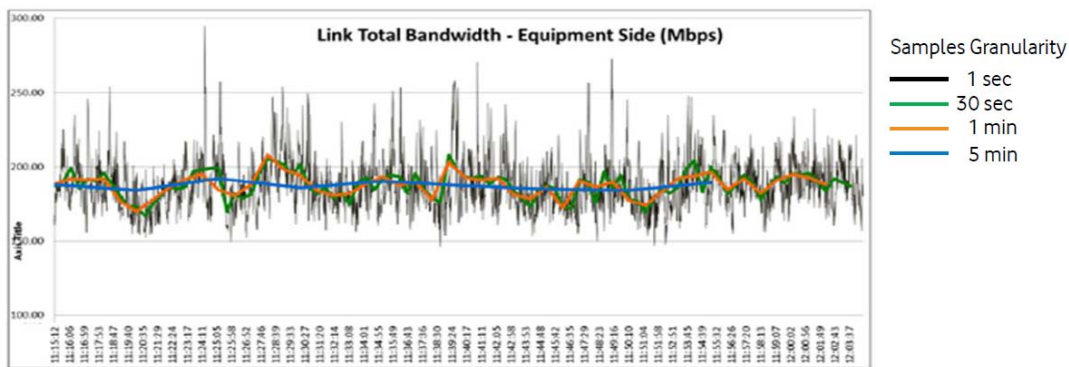

Figure 22: Backhaul link traffic measured with time granularity of 1 second, 30 seconds, 1 minute and 5 minutes

All these facts are summarized on Figure 23 with a simple chart representing a couple of RAN traffic PDF curves (measured with time granularity of 1 second and 15 minutes) and data burstiness allowance that should be guaranteed by maximum MW/mmW link capacity (PIR). RAN traffic PDF curve is shifting to the right while time granularity is getting lower (15 minutes to 1 second in this example) and RAN traffic maximum value (upper boundary) is increasing. Depending on time granularity measurements and according to data burstiness behaviour a different **extra capacity (traffic burstiness allowance)** should be allocated on top of max RAN traffic; this is a way for dimensioning PIR, that is the maximum MW/mmW link capacity to be considered for link dimensioning.

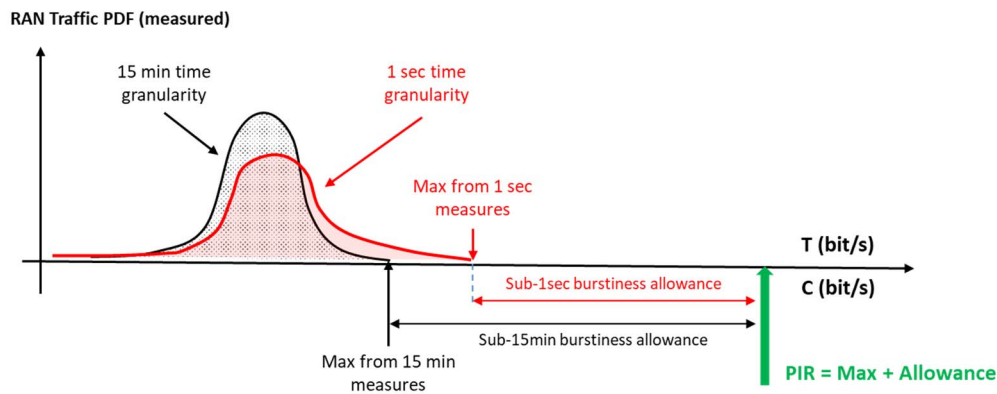

Figure 23: RAN traffic PDF and upper boundary (Max) measures plus data burstiness allowance for PIR definition

Another possible way to dimension PIR is to provide enough capacity allowing 4G/5G headline speeds that MNO would like to deliver in order to differentiate network performances: this is what can be measured by speed tests carried out during low traffic periods. Headline speed is typically related to peak RAN traffic performances of the fastest RAT layer (or sum of several RAT layers in case of carrier aggregation).

Whatever is the goal (data burstiness allowance or headline speed) for setting a PIR (max link capacity), there is no sense to set any availability target associated to PIR. This is because:

- in case of data burstiness allowance, when PIR is not available there might be slight latency increase but all RAN traffic will be delivered (also during busy hours);
- in case of headline speed, when PIR is not available there will be no possibility to reach peak RAN traffic performance with speed tests, as it happens for most of time because the network is usually loaded by traffic coming from several users.

The above minor impacts on RAN traffic do have even lower relevance considering the fact that **PIR might not be available for less than 1 day in a year** with following dimensioning criteria (part of best practice already in place today):

- 1) high (max) modulation scheme of the link (delivering PIR) should have adequate **fade margin for ensuring stable working conditions; 5 dB to 10 dB fade margin is suggested** according to frequency band and deployment region (according to rain rate and other propagation impairments).

9.4 CIR to guarantee very high-priority services

PIR is used to ensure sub second data burstiness and BTA is used to ensure that entire RAN traffic is delivered without congestion. The **minimum link capacity (CIR) is then dimensioned for guaranteeing RAN network survivability and top-priority services** for the maximum amount of time in a year (e.g. 99,995 %).

RAN network survivability contributions are the following:

- 1) **RAN Control Plane (C-Plane)** traffic depends on user activity and mobility: it is a percentage of U-Plane traffic and depending on RAN technology as listed below:
 - a) 1 % from U-Plane in case of 5G
 - b) 1 % from U-Plane in case of 4G (LTE)
 - c) 6 % in case of 3G (WCDMA)

Considering that U-Plane traffic is not static (and it will get smaller and smaller when backhaul link is approaching CIR), conservative rule of thumb for C-Plane traffic estimation is to consider 0,5 % of backhaul PIR.

- 2) **RAN Synchronization Plane (S-Plane)** depends on the synchronization method (ToP - Timing over Packet, SyncE, etc.) and it is usually less than 1 Mbps.

- 3) **RAN Management Plane (M-Plane)** traffic depends on the counter and tracing configuration. It is composed of permanent traffic (counter and tracing) and on demand traffic (periodical burst, delay-independent traffic). The permanent traffic is in the range 1 Mbps to 10 Mbps for 4G and 5G, while it is in the range of tens of kbps for 2G/3G. Rule of thumb for M-Plane traffic estimation is to consider 3 Mbps to 5 Mbps as typical range for 4G and 5G RAT layers.

Top priority services to be considered depend on MNO proposition for its own customers today and in the future. Here below there is list of possible service categories that should be considered for CIR calculation:

- 1) **Voice traffic** is the basic service (also supporting emergency calls) that is associated with CIR and basic service survivability. This is also a service strongly impacted by packet delay and packet discard. This traffic changes across MNOs networks, however; most loaded base stations show voice traffic below 30 Mbps.
- 2) **User Plane services with Guaranteed Bit Rate (GBR)** which cannot be overbooked across different sections of the transport network. This can include mission-critical voice/video, real-time traffic and 5G new use cases (e.g. Discrete automation, Intelligent Transport Systems, etc.). This is an area that is specific for each MNO and it is likely to be growing with 5G maturity thanks to 5G slicing technology.
- 3) **Any other service for which the MNO has a Service Level Agreement (SLA)** in place in terms of service availability and SLA is strictly dependent on MW/mmW link availability. This is not a typical situation across 4G and 5G networks delivering Mobile Broadband type of services today, however this might become a reality in the future 5G networks slicing use cases related to **ultra-Reliable (uR)** services.

Although precise figures for the six CIR contributors (listed above) could change across different networks (depending on number of customers, services offer and deployed RAN), it is important to provide some indications for 4G and 5G networks as depicted in Figure 24 where:

- the MNO specific components (GBR and uR services) are not estimated;
- the voice traffic component is estimated in the range 15 Mbps to 30 Mbps across lower and upper boundary tables;
- the M-Plane traffic component is estimated in the range 3 Mbps to 5 Mbps per RAT layer across lower and upper boundary;
- PIR figures (representing a typical dimensioning for 3 sectors RAN site with 60 MHz 4G FDD spectrum and 100 MHz 5G TDD spectrum) are used only to estimate C-Plane contributions.

a. Lower boundary								
	PIR (Gbps)	RAN survivability (Mbps)			Top priority services (Mbps)			CIR (Mbps)
		C-Plane	S-Plane	M-Plane	Voice	GBR	uR (SLA)	
4G site	0,5	2,5	1	3	15	0	0	21,5
5G site	2,5	12,5	1	3	15	MNO specific		31,5 + MNO specific
4G + 5G site	3	15	1	6	15	MNO specific		37 + MNO specific

b. Upper boundary								
	PIR (Gbps)	RAN survivability (Mbps)			Top priority services (Mbps)			CIR (Mbps)
		C-Plane	S-Plane	M-Plane	Voice	GBR	uR (SLA)	
4G site	0,5	2,5	1	5	30	0	0	38,5
5G site	2,5	12,5	1	5	30	MNO specific		48,5 + MNO specific
4G + 5G site	3	15	1	10	30	MNO specific		56 + MNO specific

Figure 24: CIR dimensioning for network survivability and top priority services

Tables in Figure 24 show that CIR is in the range 30 Mbps to 60 Mbps (lower and upper boundary, type of RAN site) corresponding to the case MNO specific traffic for GBR services and ultra-Reliable services is zero. These CIR figures are in the range 1 % to 2 % of PIR assumed (according to some formulas) in case of 5G (or 4G+5G) site, while they are in the range 4 % to 8 % in case of 4G site.

Consequently, CIR should not be estimated as percentage of PIR.

CIR figure can go beyond these 30 Mbps to 60 Mbps due to MNO specific GBR services and ultra-Reliable services: this depends on specific MNO customer offers and relevant amount of traffic generated by users. This additional traffic (to be considered for CIR calculation) should be estimated by MNO based on traffic measurements and expected traffic growth (for a solid future proof planning).

This extra amount of traffic has no dependency with PIR (that is just another backhaul link dimensioning parameter).

In a nutshell, following considerations hold:

- while CIR estimations (provided with rationales and data described in this clause) is a smaller figure compared with today design approach (e.g. CIR equals to 10 % to 20 % of PIR, as described in clause 5);
- the way CIR is considered in the planning is not changing on the following aspects:
 - minimum (reference) link modulation should not provide a capacity smaller than CIR; otherwise backhaul link will affect top priority services and network survivability;
 - CIR is linked to network (survivability) availability target (in the range 4 to 5 nines);
 - CIR design KPI should follow the availability objectives as set by each MNO today (99,99x % or as per Recommendation ITU-R F.2113 [i.10] for packet-based radio links or older Recommendations ITU-T G.827 [i.1] and ITU-R F.1703-0 [i.9]);
 - in the case when a link is carrying traffic from N sites, the overall $CIR_N = \sum (CIR_i)$ because this traffic cannot be overbooked.

9.5 Three check points summary

Dimensioning criteria described in previous three clauses can be summarized in the three check points approach, where MW/mmW link behaviour against propagation related fading (capacity vs availability) is bound by three KPIs:

- CIR to guarantee network survivability and top priority services with typical 4 to 5 nines availability target;
- PIR to manage data traffic burstiness (and / or headline speed) without constraints in terms of availability and with a simple physical layer dimensioning criteria (5 dB to 10 dB fading margin to ensure stable link operation);
- BTA assuring that RAN traffic is not congested for most of the time without impacting End User Quality of Experience (simulations suggesting 99,7 % to 99,9 % BTA is a safe conservative target).

This new proposed three check points planning approach can be summarized with a simple chart (see Figure 25) highlighting planning paradigm shift from two check points approach currently used today.

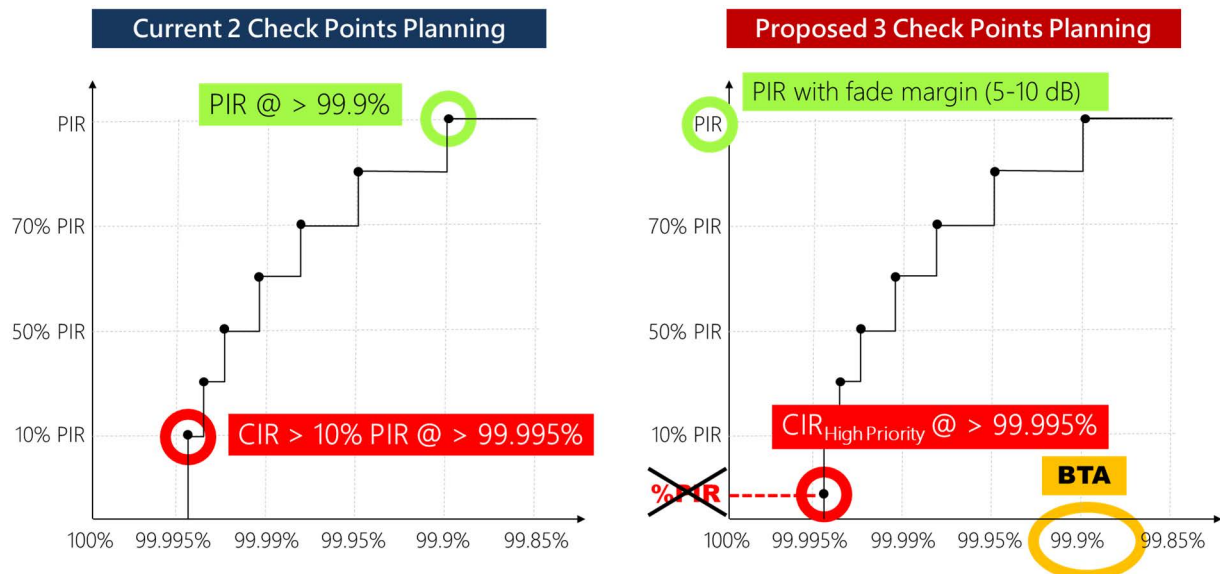

Figure 25: Three check-points approach vs two check-points approach

As it happens with two check points approach widely adopted today, also this new three check points approach foresees that all binding conditions listed above should be met. Depending on MNO network KPIs specific targets, link frequency band, link type and rainfall rate region, the link dimensioning can be driven (constrained) by either CIR, BTA or PIR.

Although the three check points can be used in different ways in the link design phase, considering the fact that BTA changes a lot depending on the assumed RAN traffic PDF (see clause 8.2), the most pragmatic way forward towards new link design approach is the following:

- CIR and PIR remain the two check points on which to base the design (with certain targets allocated to each of them as summarized above in this clause).
- BTA, as 3rd check point, will give the statistical confidence of the "adequacy" of the link to properly manage RAN traffic forecasted by MNO in coming years. In other words BTA supports (providing rationale with a strong KPI) less conservative design targets for CIR and PIR (in the paradigm shift from two check points to three check points approach).

9.6 RAN traffic PDF network measures

BTA calculation is based on RAN traffic PDF (as described in clause 9.2); beside simple theoretical worst case PDF's it is obvious that most suitable way to build RAN traffic PDF reference curves is to measure them in live networks. It is worth specifying that RAN traffic PDF to measure is either the traffic generated by one RAN site (in case of backhaul link carrying the traffic of a single RAN site) or the sum of traffic coming from multiple RAN sites (in case of backhaul link carrying the traffic of multiple RAN sites).

As described in clause 9.3, RAN traffic PDF measurement outcomes depend on the time granularity adopted (performance monitoring counters interval adopted by MNO today is typically set at 15 minutes or 5 minutes). Figure 26 provides evidence on the size of outcome differences depending on time granularity spanning from 5 seconds to 15 minutes.

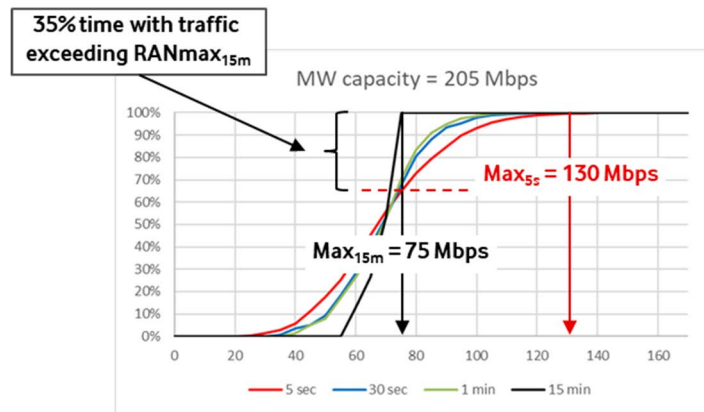

Figure 26: CDF live network measures with different PM time granularity

Considering that 5 seconds measure is the one closer to End User Quality of Experience perception (in other words it is the description of RAN traffic to be used for BTA calculation), Figure 26 highlights that 15 minutes measure is not the proper one to be used because:

- maximum RAN traffic is estimated at 75 Mbps instead of 130 Mbps (almost +100 %);
- and the blindness period (the time when RAN traffic is in between 75 Mbps and 130 Mbps) is huge, about 35 % of measurement duration.

Easy conclusion would be to adopt PM time granularity well below 5 to 15 minutes (ideally 1 second time granularity) to properly measure RAN traffic PDF. Unfortunately, there is a drawback: it generates a huge amount of data that is almost impossible to collect and challenging to store and process.

Another possibility to estimate RAN traffic PDF target (the one theoretically measured at 1 second time granularity) by collecting same amount of data as of today (e.g. one/few figures every 15 minutes) is to leverage Max and Min traffic measurements (within 15 minutes period) that all equipment delivers jointly with Average 15 minutes measurements (the useless one for RAN traffic PDF estimation). These two additional values are measured with a short sampling period (in the range of few seconds), therefore providing an upper (Max) and lower (Min) boundary to the actual RAN traffic distribution (as it would be measured with time granularity equal to sampling period): Figure 27 shows with an example the meaning of these three values (Min, Avg, Max).

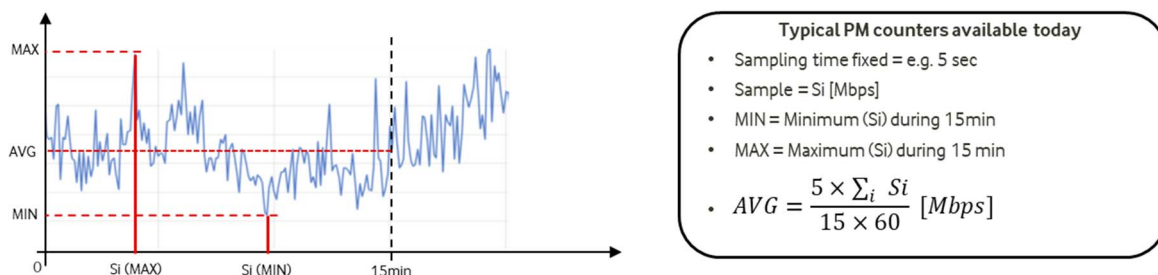

Figure 27: Min, Avg and Max figures provided by PM counters using 5 seconds sampling period

If PM counters will implement the flexibility to change sampling period (time) to measure Min and Max figures, in particular by using sampling rate of 1 second or higher, up to about 30 seconds can be used (further measurements needed before determine the best sampling choice) as shown in Figure 28, there will be the possibility to estimate an upper (Max) and lower (Min) boundary that is getting closer to RAN traffic distribution (blue line in Figure 28).

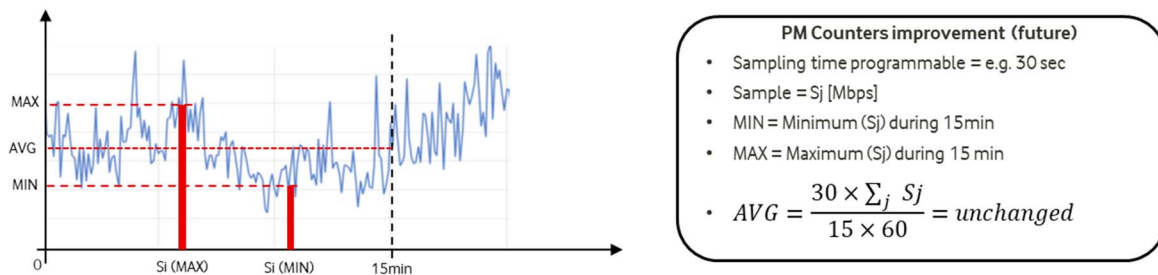

Figure 28: Min, and Max figures provided by PM counters using sampling periods larger than 5 seconds

By using some live network measurements carried out with 5 seconds time granularity (used as reference RAN traffic CDF that is estimation target) and calculating (post-processing) the (Min, Max) figures over 15 minutes periods with different sampling times (5 seconds, 30 seconds, 1 minute) it is possible to draw RAN traffic CDF upper and lower boundary as depicted in Figure 29.

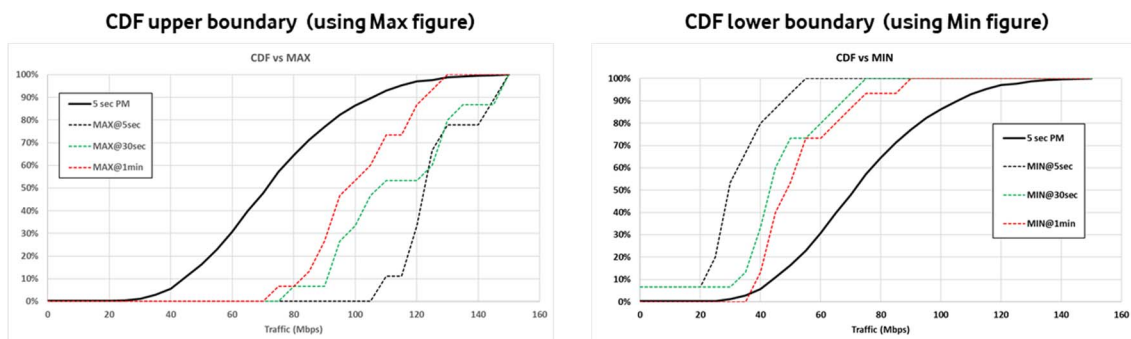

Figure 29: CDF upper (lower) boundary estimation using one Max (Min) figure every 15 minutes

From this example it seems that:

- 5 seconds sampling periods (black dotted line) provide very conservative boundaries;
- 30 seconds sampling periods (green dotted line) provide less conservative boundaries;
- 1 minute sampling periods (red dotted line) is not always providing a boundary (especially for upper boundary when CDF is approaching 100 %).

More studies and more network measures are need in order to find more suitable sampling periods (likely in the range 1 to 30 seconds) to get best RAN traffic CDF approximation (that can be derived by averaging upper and lower boundary as shown in Figure 30). However the value of this methodology is that black thick curve in Figure 30 (representing 4 hours measurement) requires $4 \times 60 \times (60/5) = 2880$ samples while each one of the dotted curves requires only $4 \times (60/15) = 16$ samples.

With this limited number of samples to be processed it is not science fiction imaging NMS and SDN Controller platforms implementing (with simple post processing) a continuous RAN traffic CDF estimation (per day, per week, etc.) upon all MW/mmW links in a network. And these RAN traffic CDF estimations can be used to build RAN traffic CDF models to be used during link dimensioning (as described in clause 9.2).

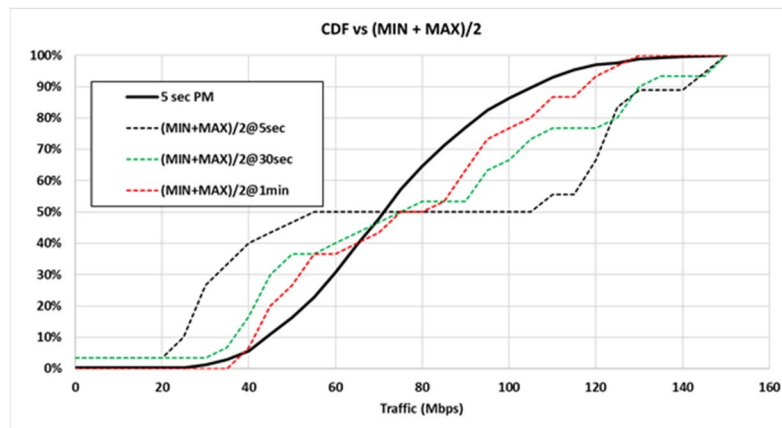

Figure 30: CDF conservative estimation using Max and Min figures every 15 minutes

10 BTA dependencies and impacts on most relevant related aspects

10.1 BTA adoption has few minor dependencies

Clause 10 aims to point out (across entire backhaul link lifecycle) whether the adoption of the new BTA KPI deserves something new (dependencies) and/or creates disruptions (impacts) on network planning, equipment standards and spectrum rules.

As explained across this clause, BTA adoption deserves only simple adaptations for planning tools, while there are no dependencies or impacts on equipment standards and spectrum rules. This means that MNOs can go for a smooth and quick BTA introduction in the short term since there are no showstoppers. The only challenging aspect for start using BTA (jointly with other KPIs - as explained in clause 9) is the paradigm shift described in the present document.

10.2 Network planning

Before getting into description of network planning adaptations required for managing BTA it is important remarking the fact that **nothing changes on propagation related fading prediction models [i.5]**; planning tools will continue calculating availability (outage) of all MW/mmW link modes as of today.

Planning tools should instead implement an additional module capable to evaluate BTA by using:

- a vector of capacity and availability pairs (calculated in the same way as of today) describing the MW/mmW link capacity degradation against propagation related fading;
- a RAN traffic PDF curve.

Formulae for this calculation are very simple as described in clause 6. Depending on MNOs peculiarities in the way BTA will be managed within the link planning process, it is foreseen that RAN traffic PDF input should be supported by planning tools in different ways such as:

- picking up one PDF model from a PDF library (repository): this library will be populated by MNO with suitable models coming from its network measures (e.g. addressing different RAT layers and spectrum within RAN site, number of RAN sites backhauled, rural and urban scenarios, etc.);
- using beta cumulative distribution functions or PDFs (as described in clause 8): with either baseline calculation against a specific beta function (MNO will define (a, b) parameters of beta function) or by calculating BTA against a set of possible beta function parameters (a, b) as described below.

BTA calculation against a set of possible beta function parameters (a, b) can easily be done and it will generate sort of heat map describing link BTA against a huge variety of RAN traffic PDFs. As described with example in Figure 31, this **BTA heat map becomes a sort of signature** for a certain MW/mmW link deployed in a specific rain region.

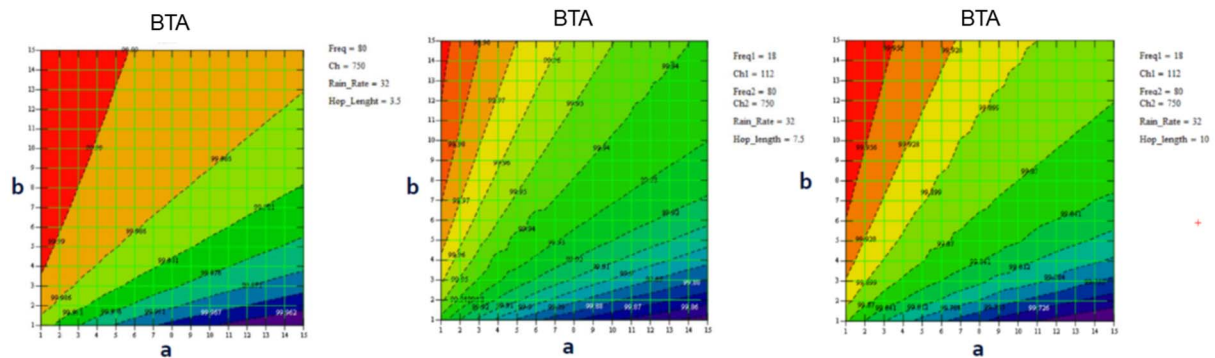

Figure 31: 7 BTA heat maps ($1 < (a, b) < 15$) for three links deployed in 32 mm/hr rain rate region

With this BTA heat map (signature), MNO can easily understand what will happen when traffic grows in the future, being able to assess what/if scenarios and to take decisions on link capacity upgrade in due time. Figure 32 shows an example of BTA degradation (from 99,995 % to 99,980 %) when average RAN traffic will increase of about 3 times (cyan vs red curve in the right most chart on Figure 32).

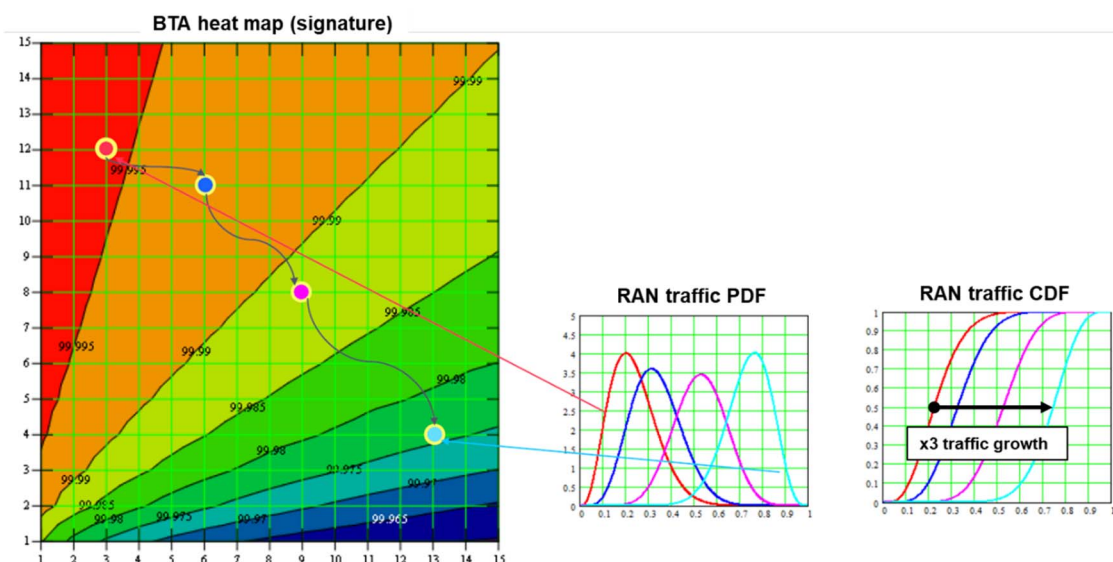

Figure 32: 7 BTA heat maps for analysing RAN traffic growth (what/if scenarios)

10.3 Equipment standards

There are no dependencies (impacts) from (on) equipment standards ETSI EN 302 217-1 [i.8] in order to introduce BTA based link planning. This is because this new planning approach has been developed for addressing existing MW/mmW products using existing and well consolidated technologies (ACM and BCA) that are embedded into existing equipment standards mentioned above.

This fact does not prevent that product improvements might take place across the industry in order to better support BTA approach. Just to provide an example it is worth mentioning the necessity for PM counter improvements in order to perform more accurate RAN traffic PDF network measures (as described in clause 9.5).

10.4 Spectrum regulations and licensing

BTA introduction in the link dimensioning process adopted by MNOs does not change the maximum spectral efficiency achieved by a MW/mmW link in a given band (or set of bands in case of a BCA link). Actually BTA introduction is improving overall spectrum usage efficiency because it allows MNOs using high frequency bands (mmW) for longer hops as explained in clause 8.

Also in terms of spectrum coordination (to avoid interference in case of individual licensing) there are no impacts since each MW/mmW link will continue using existing technologies (ACM and BCA, as described in clause 10.2) that have already been considered by Administrations within licensing process in place today.

Annex A: BTA concept extension from single link to multi hop link topologies

In case of multi hop topologies, the planning and apportionment of link availability targets across different links is a well-established methodology based on Recommendation ITU-R F.1703-0 [i.9] or Recommendation ITU.T G.827 [i.1]. This is not changing with introduction of BTA since link availability is still linked to CIR as described in clause 9.5. On the other hand PIR does not have anymore any associated availability target, therefore there is no need to have a methodology to manage target apportionment across multi hop topologies.

The new BTA do instead deserves a methodology to manage target apportionment across multi hop topologies because it represents the probability to create traffic congestions. Following considerations focus only on the "propagation induced" effects and not on other causes that can produce outages in the transport network (such as equipment failure, power failure, etc.).

The new BTA KPI defined in the present document (see clause 6) has been developed focusing on RAN traffic (T) and backhaul link capacity (C) statistical random variables relationship for a single link carrying the traffic of a single RAN site (as depicted in Figure A.1a). This is the simplest network topology with single hop towards fibre POP; in this case it is straightforward assigning to this link a $(1-BTA)$ target equal to overall MW backhaul congestion probability target (MW_{cong}) as described in clause 8.2.

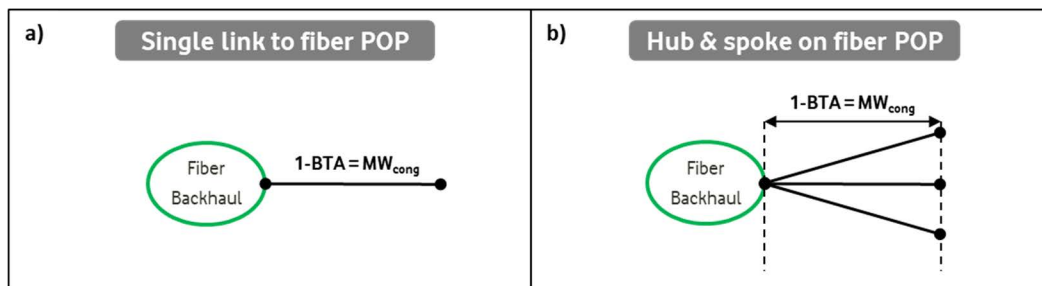

Figure A.1: BTA targets setting for a) single hop and b) hub & spoke network topologies

Another widely adopted topology is the hub & spoke represented in Figure A.1b), where multiple links are connected to the same fibre POP with single wireless hop. This is general case of single link and it is straightforward assigning to all these links a $(1-BTA)$ target equal to overall MW backhaul congestion probability target (MW_{cong}).

A more challenging topology is when multiple cascaded hops (i.e. in a daisy chain) carry the traffic of multiple RAN sites collected along the chain. Figure A.2 represents the simplest daisy chain with two cascading link (L_a , L_b) backhauling two radio sites ($RS1$ and $RS2$ highlighted with red dots in Figure A.2): L_b is carrying $RS2$ traffic (T_2) only, while L_a is carrying $RS1 + RS2$ traffic (T_1+T_2). Therefore, it is possible calculating both:

- $(1-BTA)_a = a =$ congestion probability for L_a as a function of T_1+T_2 traffic PDF.
- $(1-BTA)_b = b =$ congestion probability for L_b as a function of T_2 traffic PDF.

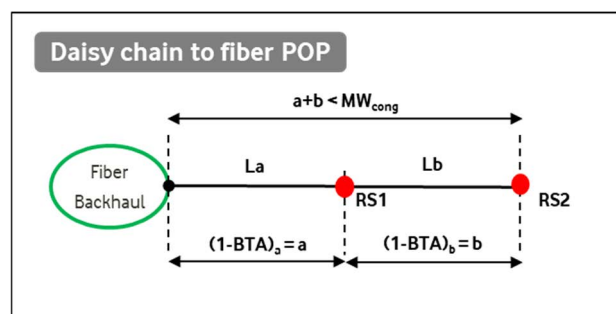

Figure A.2: BTA targets setting for daisy chain of two cascading hops

Assuming 100 % decorrelation between propagation related fading probabilities on La and Lb, the overall congestion probability for RS2 traffic is the sum $a + b$ and this is the probability that should not exceed the overall congestion probability MW_{cong} . This conservative assumption (100 % decorrelation between propagation related fading over the two links) is the same assumption considered for planning link availability objectives of daisy chain topologies according to Recommendation ITU-R F.1703-0 [1.9].

Therefore the MNO could set this condition:

$$a + b = (1-BTA)_a + (1-BTA)_b < MW_{\text{cong}}$$

to ensure that wireless backhaul network will not create congestions probability exceeding its own target for RS2.

When this condition is met the congestion probability for RS1 (a), that is affected only by condition of link La, will also be met ($a < MW_{\text{cong}}$). Therefore some criteria to apportion MW_{cong} between a and b should be used.

One possibility is to consider this fact: when La gets congested there are two radio sites (RS1 and RS2) that will suffer congestions, therefore with a bigger (double) network impact compared with the situation when Lb only is congested (impacting only RS2). As a consequence the MNO might set the condition that $a = b/2$, that will lead to following apportionment (depicted in Figure A.3):

$$a + b = b/2 + b < MW_{\text{cong}} \text{ that is } b < 2 * MW_{\text{cong}} / 3$$

$$a < MW_{\text{cong}} / 3$$

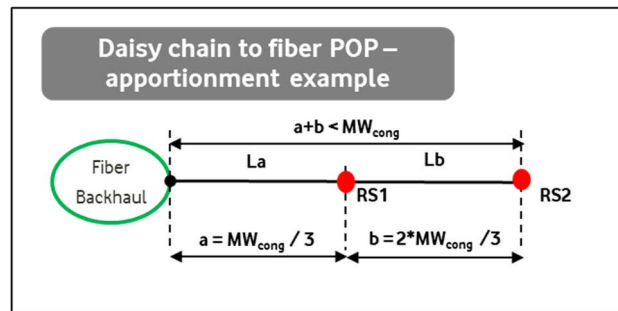

Figure A.3: BTA targets apportionment for daisy chain of two cascading hops

The general case of multiple hops and/or hub & spoke along daisy chain can be derived with similar rationales.

Annex B: User Experience vs BTA - simulations details

B.1 E-Band link backhauling one 5G NR site: VR, gaming and FTP services

B.1.0 Introduction

Annex B aims at investigating the relationship between the BTA metric defined for wireless Backhaul links (presented in clause 6) and the level of quality of service that is experienced by the end users in the Radio Access Network (RAN). This goal will be pursued by relying on performance data derived through system-level simulations able to capture the interactions between the RAN and the wireless Backhaul realms.

Clause B.1.1 presents the main assumptions and models employed in the simulation campaigns, while clause B.1.2 focuses on the analysis of the achieved results.

B.1.1 Simulation Models and Assumptions

B.1.1.0 Network scenario and network simulator

Simulations focus here is on the downlink (DL) scenario depicted in Figure B.1, where N wireless users employing a 5G New Radio access technology [i.11] are connected to a Next Generation NodeB (gNB) that provides coverage to three hexagonal sectors, each with radius equal to 165 m. The users are randomly spread across the covered region, and a 4:1 DL-to-UL frame ratio is selected. RAN communications take place over a 100 MHz bandwidth centred at 3,5 GHz carrier frequency, and each gNB-to-user propagation channel is modelled as described in ETSI TR 138 901 [i.12]. Each n th wireless user requires traffic data from a remote server which generates packets according to a service-specific statistical flow process $\mu_n(t)$, e.g. as specified in 3GPP TR 38.838 [i.13] for Extended Reality (XR) and 3GPP TR 36.814 [i.14] for File Transfer Protocol (FTP) service.

The gNB is connected to the Core Network through a wireless Backhaul link that employs a frequency channel with 250 MHz width over the vertical polarization of the electromagnetic field in E-band (82 GHz carrier frequency). Due to the use of ACM technology, the available capacity C_{BH} over the wireless Backhaul link can assume one value within the discrete set $\{189, 379, 569, 759, 949, 1\ 139, 1\ 329, 1\ 519, 1\ 708, 1\ 803\}$ Mbit/s, according to the attenuation level affecting the propagation channel.

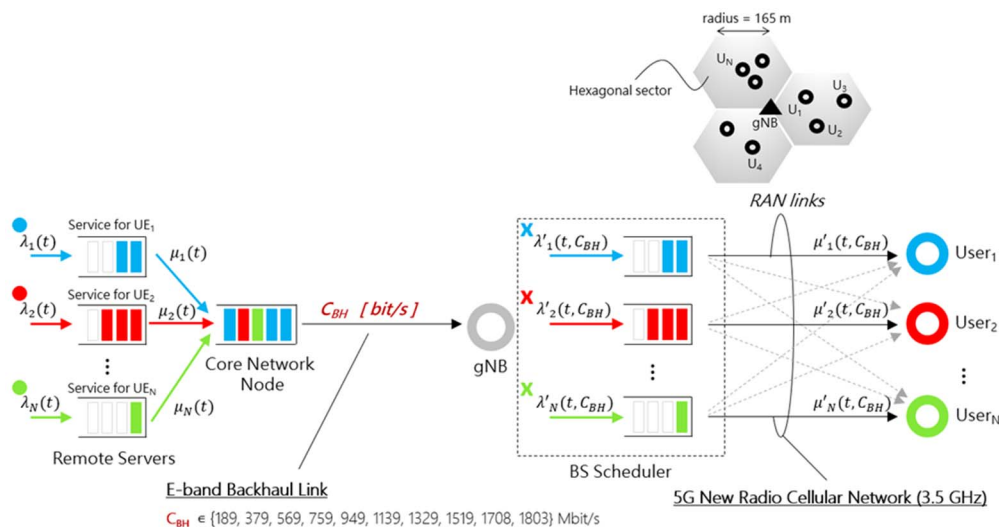

Figure B.1: Simulation scenario where one three-sectorial 5G New Radio site operating at 3,5 GHz is connected to the Core Network through a Backhaul link employing E-band technology

A single buffer with virtually infinite length is modelled at the transmit side of the Backhaul link to host the incoming packets from the N remote servers before transmission. Buffers are also implemented at the gNB to host the packets flows $\{\lambda'_n(t, C_{BH})\}_{n=1}^N$ intended for the different wireless users before the respective transmission opportunities are granted by the overall scheduling process. Notice that the statistical behaviors of the different packets flow processes $\{\lambda'_n(t, C_{BH})\}_{n=1}^N$ strongly depend on the level of the available finite Backhaul capacity C_{BH} , such that in this scenario generally $\lambda'_n(t, C_{BH}) \neq \mu_n(t)$ for each $n = 1, 2, \dots, N$. Whenever not otherwise specified, communications to the wireless users connected to the same gNB sector are scheduled according to a round-robin time division multiple access criterion, while transmissions to users served by different sectors are handled independently and can thus occur simultaneously, creating cross-sector interference. It is worth remarking that no traffic congestion management mechanisms or queue admission control policies provided by the higher layer radio network protocols are implemented here. As a matter of fact, this will lead to conservative outcomes in the numerical analysis that is presented in clause B.1.2.

A review of the employed models for the statistical packets flow processes $\mu_n(t)$ ($n = 1, 2, \dots, N$) is presented in the remaining part of this clause and it is summarized in Figure B.2.

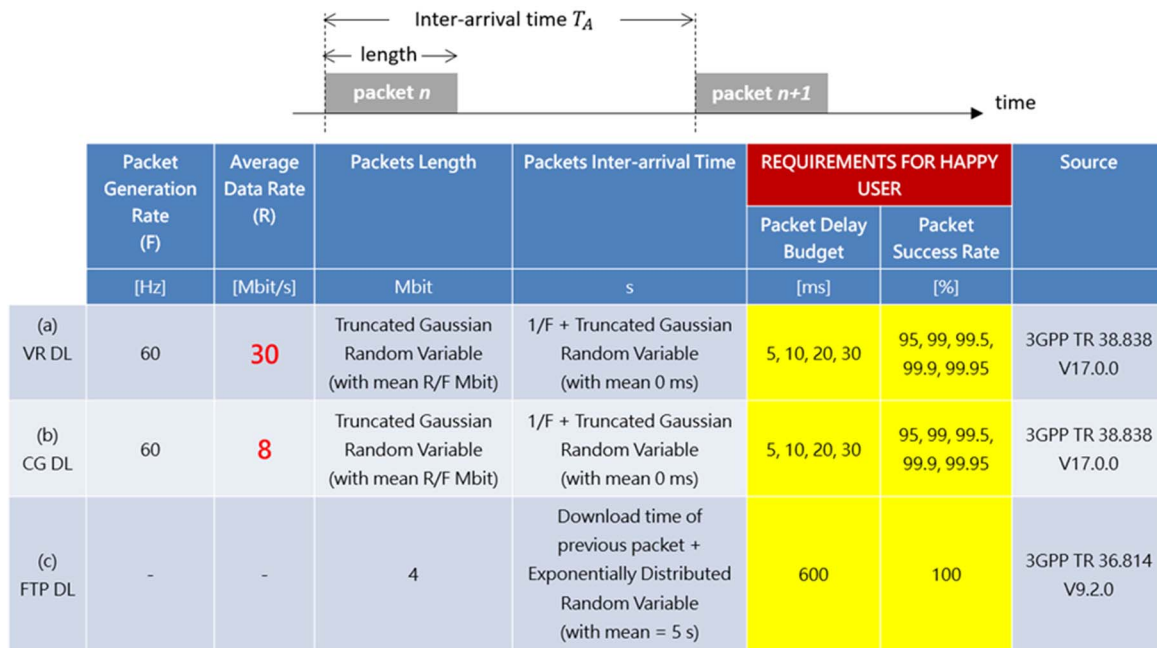

Figure B.2: Traffic model assumptions

B.1.1.1 Virtual Reality Downlink (VR DL) Stream Model

Following the guidelines in 3GPP TR 38.838 [i.13] for single stream traffic, a Virtual Reality Downlink (VR DL) flow process is here modelled as a sequence of packets (each accounting for the set of IP packets belonging to the same video frame) generated at the remote server with an inter-arrival time:

$$T_A^{(VR)} = \frac{1}{F} + x \quad [\text{s}]$$

that is determined by a fixed term depending on the application-specific packet generation rate F (in [packets/s]) and a random jitter contribution x accounting for the varying encoding delay of the video frames and the variable network transfer time introduced in a realistic scenario. More specifically, the jitter follows a truncated Gaussian distribution with statistical parameters as shown in Table B.1.

Table B.1: Statistical parameters of packets jitter distribution for VR DL services

Parameter	Unit	Value
Mean	ms	0
Standard deviation	ms	2
Truncation range	ms	[-4, 4]

The size of each packet is also stochastic, and it is modelled as a random variable following a truncated Gaussian distribution whose statistical parameters depend on both the application-specific average data rate R in [Mbit/s] of the flow and the application-specific packet generation rate F in [packets/s], with mean, standard deviation (before the truncation), maximum and minimum admissible values as shown in Table B.2.

Table B.2: Statistical parameters of packets size distribution for VR DL services

Parameter	Unit	Values
Mean	bit	$R \times 10^6 / F$
Standard deviation	bit	10.5% of Mean
Max	bit	150% of Mean
Min	bit	50% of Mean

In the simulation results shown in the present document, a packet generation rate $F = 60$ packets/s and an average data rate $R = 30$ Mbit/s have been selected for each VR DL packets flow process. Accordingly, the *average* inter-arrival periodicity of the packets reads:

$$E[T_A^{(VR)}] = \frac{1}{F} = 16,6667 \text{ ms.}$$

B.1.1.2 Cloud Gaming Downlink (CG DL) Stream Model

The Cloud Gaming Downlink (CG DL) packets flow process follows the same model as the one described in clause B.1.1.1 for the VR DL scenario, here with average data rate $R = 8$ Mbit/s [i.13].

B.1.1.3 File Transfer Protocol Downlink (FTP DL) Stream Model

An FTP DL flow process (for a single RAN wireless user) is here modelled as a sequence of packets each with fixed size equal to 4 Mbit, following the guidelines in 3GPP TR 36.814 [i.14]. The inter-arrival time between any j th and $(j+1)$ th packet is assumed to be equal to the download time of the j th packet plus a reading time that is modelled as an exponentially distributed random variable with a mean equal to 5 seconds.

B.1.1.4 The Happy User

The assessment of the RAN performance carried out in clause B.1.2 is based on the count of the number of *happy users*, i.e. the wireless users experiencing a connection quality that complies with a specific set of target requirements. Within this study, a user requesting a given data service is defined as *happy* if X % of the received packets undergo an *overall delay* lower than an application-specific target Packet Delay Budget (PDB). The *overall delay* of a given packet is here measured as the difference between the instant when the packet is successfully transferred to the intended wireless user over the RAN and the time when it reaches the transmit Backhaul buffer (see Figure B.1). According to the notation adopted in 3GPP TR 38.838 [i.13], the aforementioned parameter X will be referred to as Packet Success Rate across clause B.1.

As for the VR DL and the CG DL traffic flow processes described in clauses B.1.1.1 and B.1.1.2, different combinations of PDB and Packet Success Rate will be investigated in the numerical analysis presented in clause B.1.2 as target requirements for the *happy users*, with the goal of providing a thorough performance overview. More specifically, a PDB equal to 5, 10, 20 or 30 ms and a Packet Success Rate equal to 95 %, 99 %, 99,5 %, 99,9 % or 99,995 % will be considered. Notice that the set of combinations of requirements investigated in this study contains the ones suggested in 3GPP TR 38.838 [i.13] as baseline values for performance evaluations.

Furthermore, a RAN wireless user running an FTP service as described in clause B.1.1.3 is here considered *happy* if all the requested packets are received with an overall delay lower than 0,6 seconds (i.e. Packet Success Rate = 100 % and PDB = 0,6 seconds). Notice, as a reference, that the latter time requirement would correspond to a Quality of Experience (QoE) value greater than 4 (on a scale of 1 to 5) for Web browsing application considered in Figure B.16.

B.1.2 Numerical Analysis

B.1.2.0 Simulation results and methodology

A typical outcome of a simulation campaign carried out through the Wireless Backhaul and RAN system-level simulator employed in this study is represented in Figure B.3, where a bi-dimensional table gathers the percentages of *happy users* for different RAN loads (in terms of number N of simultaneously active RAN wireless users, varying along the rows) and for different available Backhaul capacities C_{BH} (varying along the columns). In this case, 100 % of the wireless users are assumed to run VR DL services as modelled in clause B.1.1.1 (with $R = 30$ Mbit/s average per-user traffic data rate), and each user is considered *happy* if 99 % of the received packets undergo an overall delay lower than 10 ms (Packet Success Rate = 99 %, PDB = 10 ms).

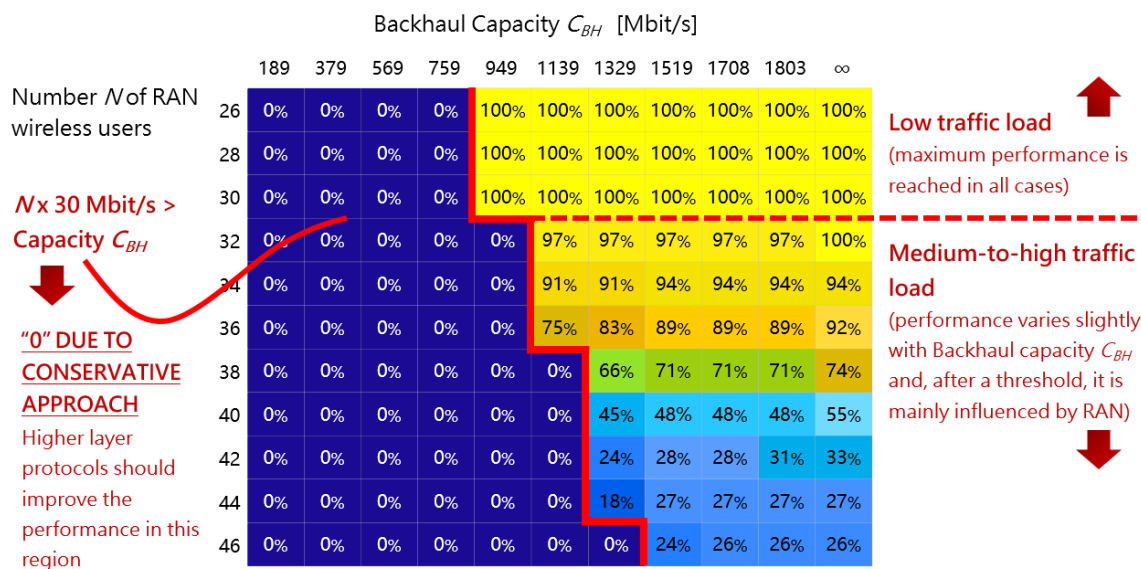

Figure B.3: Typical outcome of a simulation campaign carried out through the Wireless Backhaul and RAN system-level simulator employed in this study

It is worth remarking that, with no traffic congestion control mechanisms implemented in the Wireless Backhaul and RAN system-level simulator, any average aggregated RAN traffic data rate (equal to $N \times 30$ Mbit/s) that is higher with respect to the available Backhaul capacity C_{BH} cannot be sustainable as the occupancy of the transmit Backhaul buffer would virtually grow without boundaries. In this fully congested scenario - that, specifically, occurs in the dark blue region below the stepwise red solid line in the table of Figure B.3 - there are no *happy users* as most of the packets are dropped, and the few packets reaching the intended destinations experience an overall delay that is far above the target requirements.

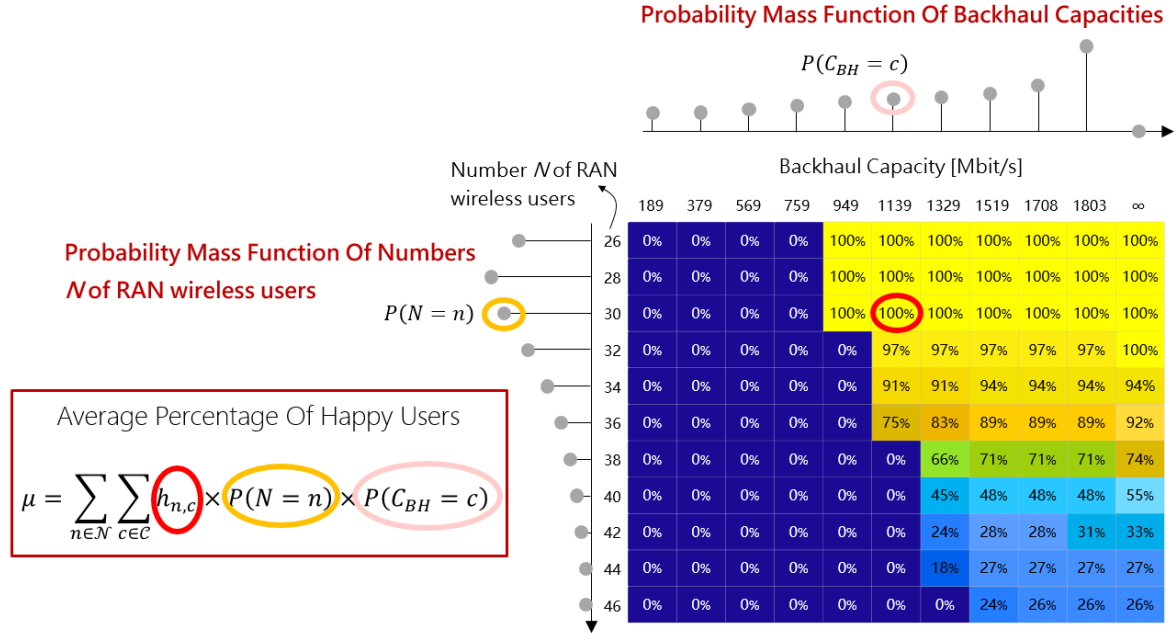

Figure B.4: Definition of Average Percentage Of Happy Users

As a compact metric for expressing the performance experienced by the RAN wireless users, it is worth defining the Average Percentage Of Happy Users μ as the following weighted sum of terms:

$$\mu = \sum_{c \in \mathcal{C}} \sum_{n \in \mathcal{N}} h_{n,c} \times P(N = n) \times P(C_{BH} = c),$$

where, with reference to Figure B.4,

- $h_{n,c}$ is the percentage of *happy users* obtained by the Wireless Backhaul and RAN system-level simulator when $N = n$ simultaneously active RAN wireless users and a Backhaul capacity $C_{BH} = c$ are considered;
- $P(N = n)$ is the probability that n RAN wireless users are simultaneously active;
- $P(C_{BH} = c)$ is the probability that a certain maximum capacity c can be delivered by the wireless Backhaul link (this term can be computed, e.g. by following the guidelines in Recommendation ITU-R P.530-18 [i.5]);
- \mathcal{C} is the set of the admissible capacities that can be delivered over the wireless Backhaul link ($\mathcal{C} = \{189, 379, 569, 759, 949, 1139, 1329, 1519, 1708, 1803\}$ Mbit/s in the scenario considered here);
- \mathcal{N} is the set of the numbers of simultaneously active RAN wireless users that have been tested in the simulation campaign ($\mathcal{N} = \{26, 28, 30, \dots, 46\}$ in the example of Figure B.4).

In the following clauses, the simulated performance in terms of BTA and Average Percentage Of Happy Users μ will be shown with focus on three different traffic scenarios.

B.1.2.1 100 % Of RAN Wireless Users Running Virtual Reality Downlink Services

In the present clause, focus is on the scenario depicted in Figure B.1 with 100 % of the active wireless users running VR DL services, according to the statistical model described in clause B.1.1.1. Figure B.5 shows the performance in terms of Average Percentage Of Happy Users μ and BTA by focusing on a network scenario with an annual rainfall rate exceeded for 0,01 % of an average year equal to 60 mm/h, see Recommendation ITU-R P.837-7 [i.6]. Herein, each user is considered *happy* if 99 % of the received packets experience an overall delay lower than 10 ms (Packet Success Rate = 99 %, PDB = 10 ms).

With reference to Figure B.4, the numbers N of simultaneously active RAN wireless users and their associated probability mass function have been selected so as to derive two reference statistical distributions of the aggregated RAN traffic data rate (here measured with a 5,3 ms integration time granularity) that is requested by the gNB (and, consequently, that is transported over the wireless Backhaul link):

- i) an aggregated traffic data rate distribution with a peak-to-median ratio equal to 4,7 and with a peak traffic data rate value equal to 1 754 Mbit/s (used to obtain the performance in Figure B.5(a)); and
- ii) an aggregated traffic data rate distribution with a peak-to-median ratio equal to 3 and with a peak value equal to 1 822 Mbit/s (used to obtain the performance in Figure B.5(b)).

The probability mass function of the Backhaul capacities C_{BH} (see Figure B.4) has been derived by considering the radio propagation over the Backhaul link affected by free-space path loss, oxygen and water vapor absorption, rain fading and clear-air multipath fading according to the guidelines in Recommendation ITU-R P.530-18 [i.5] (pressure = 1 013,25 hPa; temperature = 15°; water vapor density = 7,5 g/m³; refractivity gradient = -780 N-unit/km; area surface roughness = 200 m; transmitter height = 190 m; receiver height = 200 m; transmitter and receiver antenna diameter = 60 cm). In both Figure B.5(a) and Figure B.5(b), a maximum number of simultaneously active RAN wireless users equal to 51 over the three cellular sectors has been selected. For the sake of completeness, the cumulative distribution functions of the two reference aggregated RAN traffic data rate processes are plotted in Figure B.6.

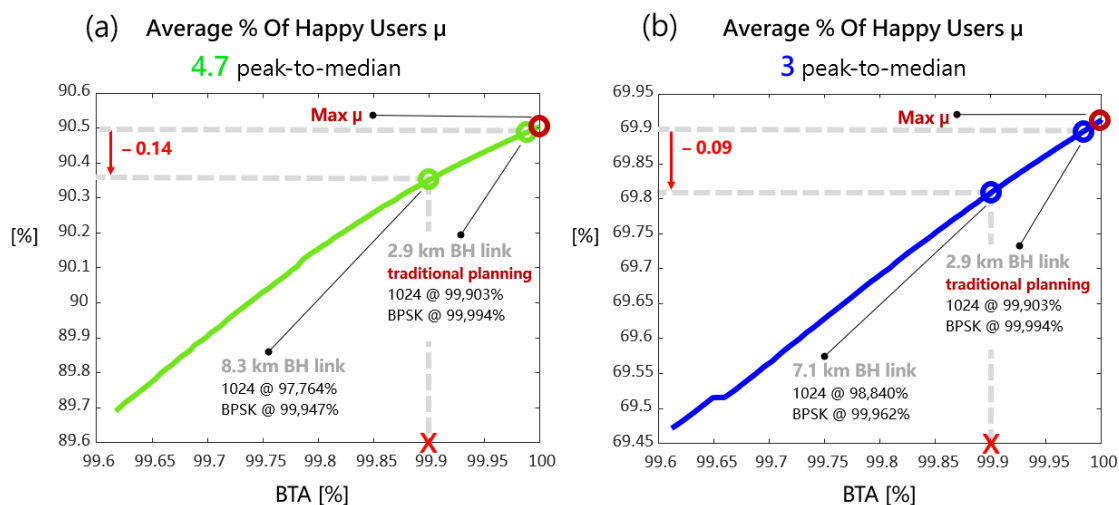

NOTE: A peak-to-median ratio of the aggregated RAN traffic data rate that is requested by the gNB equal to 4,7 (a) and 3 (b) has been considered, with a peak traffic data rate value equal to 1 754 Mbit/s (a) and 1 822 Mbit/s (b).

Figure B.5: Average Percentage Of Happy Users μ and BTA for the scenario of Figure B.1 with 100 % of users running VR DL services and rainfall region of 60 mm/h

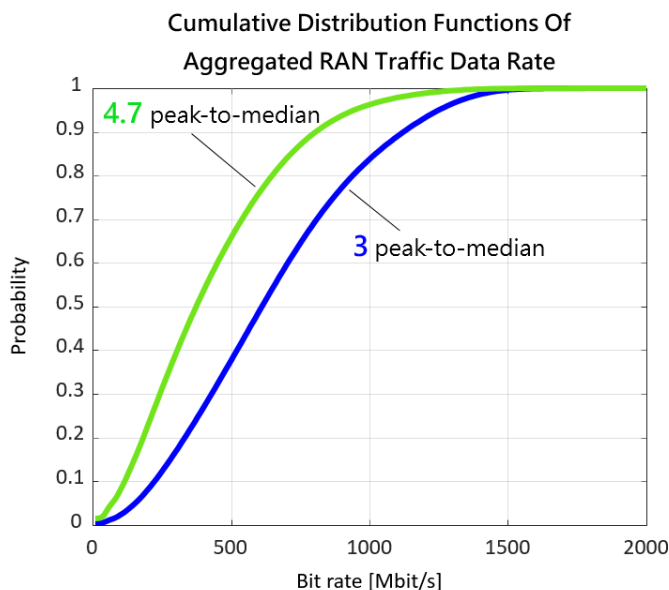
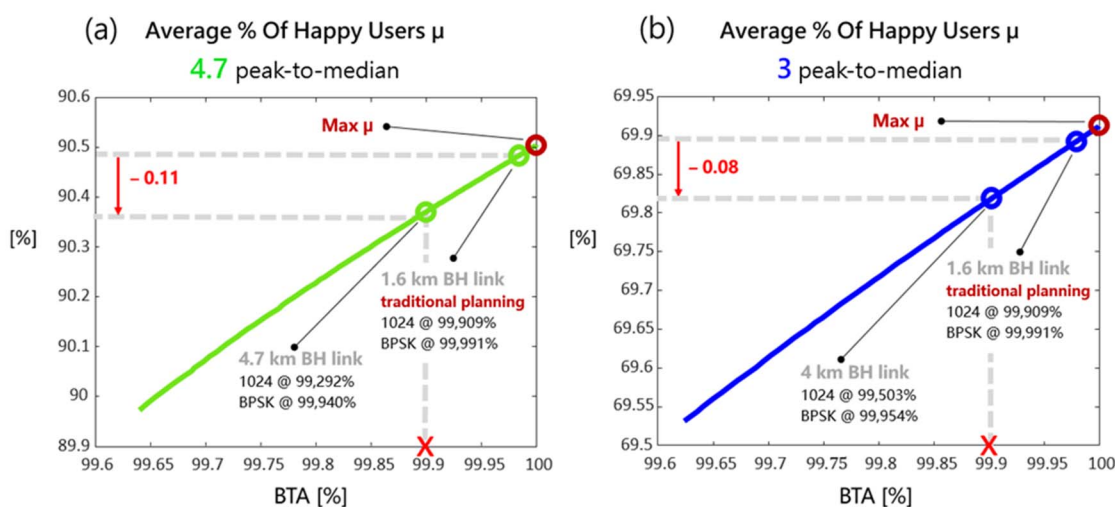

Figure B.6: Cumulative distribution functions of the two reference aggregated RAN traffic data rate processes employed for deriving the performance shown in this clause

It is worth remarking that the maximum value of the Average Percentage Of Happy Users μ in both Figures B.5(a) and B.5(b) (highlighted by the red circles) is determined exclusively by the RAN status, as it is achieved by relying on a wireless Backhaul link that experiences ideal propagation conditions and that can deliver the maximum capacity of 1 803 Mbit/s (corresponding to the highest possible modulation format) with 100 % availability. The other points of the curves are derived by considering increasing lengths of the Backhaul link. Traditional planning criteria for the Backhaul connection pursuing, for example, an availability requirement at least equal to 99,9 % for the maximum capacity (1 803 Mbit/s in this case) and an availability requirement at least equal to 99,99 % for the minimum capacity (189 Mbit/s in the scenario at hand) would lead to a wireless Backhaul link length not longer than 2,9 km. Both Figures B.5(a) and B.5(b) suggest that adopting the BTA as new Backhaul planning metric and setting its target value to 99,9 % would lead to a 2,4x to 2,9x gain in the feasible distance of the Backhaul link - i.e. from 2,9 km to 7,1 km (b) or to 8,3 km (a) - with a negligible drop in the Average Percentage Of Happy Users μ , namely lower than 0,14 percentage points in the studied cases. Notice that a less conservative analysis accounting for traffic congestion control policies provided by the higher layer radio network protocols would have brought an even smaller RAN performance loss (see also the discussion at the beginning of clause B.1.1).



NOTE: A peak-to-median ratio of the aggregated RAN traffic data rate that is requested by the gNB equal to 4,7 (a) and 3 (b) has been considered, with a peak traffic data rate value equal to 1 754 Mbit/s (a) and 1 822 Mbit/s (b).

Figure B.7: Average Percentage Of Happy Users μ and BTA for the scenario of Figure B.1 with 100 % of users running VR DL services and rainfall region of 145 mm/h

The same conclusion holds for Figure B.7, that focuses on an annual rainfall rate exceeded for 0,01 % of an average year equal to 145 mm/h (other system parameters and assumptions are the same as in Figure B.5).

Notice that, in this case, a distance equal to 1,6 km should be considered as the reference Backhaul link length achievable with the traditional planning criterion dictating a target availability at least equal to 99,9 % for the maximum capacity and a target availability at least equal to 99,99 % for the minimum capacity, while adopting the BTA as new Backhaul planning metric and setting its target value to 99,9 % would allow to reach 4,7 km or 4 km with an aggregated RAN traffic data rate distribution having peak-to-median ratio equal to 4,7 or 3, respectively - still with a negligible drop in the Average Percentage Of Happy Users μ (lower than 0,11 percentage points).

These results are further stressed by the performance shown in the tables of Figures B.8 and B.9 for an annual rainfall rate exceeded 0,01 % of an average year equal to 60 mm/h and 145 mm/h, respectively. Other system parameters and assumptions are the same as in Figure B.5, with a peak-to-median ratio of the aggregated RAN traffic data rate process requested by the gNB here fixed to 3. Each table is derived by considering a fixed Backhaul link length (0 km, 2,9 km or 1,6 km, and 0 km, 7,1 km or 4 km), and shows the Average Percentage Of Happy Users μ achieved by selecting different combinations of PDB (varying along the columns) and Packet Success Rate (varying along the rows) requirements for the *happy users*. Notice that, in each figure, while table (a) explicitly reports the Average Percentage Of Happy Users μ achieved in the different cases, tables (b) and (c) highlight the drop in the Average Percentages Of Happy Users with respect to table (a) in percentage points, in order to ease a comparative analysis. Herein, a Backhaul link distance equal to 0 km refers to a scenario where the wireless Backhaul link experiences ideal propagation conditions and can deliver the maximum capacity of 1 803 Mbit/s (corresponding to the highest possible modulation format) with 100 % availability. It is worth remarking that, for all the combinations of PDB and Packet Success Rate requirements, the drop in the Average Percentage Of Happy Users μ keeps below 0,025 percentage points from a Backhaul link length of 0 km to 2,9 km and below 0,14 percentage points from 2,9 km to 7,1 km in Figure B.8, while it is below 0,03 percentage points from 0 km to 1,6 km and below 0,12 percentage points from 1,6 km to 4 km in Figure B.9.

(a) Average % Of Happy Users

Backhaul link length = 0 km, BTA = 100 %

		Packet Delay Budget			
		5 ms	10 ms	20 ms	30 ms
Packet Success Rate	95 %	38,919 %	81,769 %	93,188 %	97,926 %
	99 %	13,078 %	69,911 %	89,596 %	95,241 %
	99.5 %	8,682 %	62,491 %	87,572 %	93,188 %
	99.9 %	2,112 %	43,392 %	83,353 %	90,585 %
	99.95 %	0,816 %	36,580 %	79,897 %	89,604 %

(b) Drop in Average % Of Happy Users with respect to (a) in percentage points

Backhaul link length = 2.9 km, BTA = 99.984 %

		Packet Delay Budget			
		5 ms	10 ms	20 ms	30 ms
Packet Success Rate	95 %	0,010	0,019	0,023	0,025
	99 %	0,003	0,016	0,021	0,024
	99.5 %	0,002	0,013	0,021	0,023
	99.9 %	0,001	0,009	0,020	0,022
	99.95 %	0,000	0,007	0,018	0,022

(c) Drop in Average % Of Happy Users with respect to (a) in percentage points

Backhaul link length = 7.1 km, BTA = 99.9 %

		Packet Delay Budget			
		5 ms	10 ms	20 ms	30 ms
Packet Success Rate	95 %	0,068	0,123	0,153	0,167
	99 %	0,016	0,104	0,142	0,160
	99.5 %	0,015	0,087	0,137	0,153
	99.9 %	0,004	0,055	0,130	0,144
	99.95 %	0,001	0,047	0,118	0,143

NOTE: Other system parameters are selected as in Figure B.5 (rainfall rate exceeded for 0,01 % of an average year = 60 mm/h), except for a peak-to-median ratio of the aggregated RAN traffic data rate process requested by the gNB = 3.

Figure B.8: Average Percentage Of Happy Users μ and BTA for the scenario of Figure B.1 with 100 % of users running VR DL services and for different Backhaul link lengths (0 km, 2,9 km, 7,1 km)

(a) Average % Of Happy Users

Backhaul link length = 0 km, BTA = 100 %

		Packet Delay Budget			
		5 ms	10 ms	20 ms	30 ms
Packet Success Rate	95 %	38,919 %	81,769 %	93,188 %	97,926 %
	99 %	13,078 %	69,911 %	89,596 %	95,241 %
	99.5 %	8,682 %	62,491 %	87,572 %	93,188 %
	99.9 %	2,112 %	43,392 %	83,353 %	90,585 %
	99.95 %	0,816 %	36,580 %	79,897 %	89,604 %

(b) Drop in Average % Of Happy Users with respect to (a) in percentage points

Backhaul link length = 1.6 km, BTA = 99.980 %

		Packet Delay Budget			
		5 ms	10 ms	20 ms	30 ms
Packet Success Rate	95 %	0,012	0,023	0,028	0,030
	99 %	0,004	0,020	0,026	0,029
	99.5 %	0,003	0,017	0,026	0,028
	99.9 %	0,001	0,011	0,024	0,027
	99.95 %	0,000	0,009	0,023	0,026

(c) Drop in Average % Of Happy Users with respect to (a) in percentage points

Backhaul link length = 4 km, BTA = 99.9 %

		Packet Delay Budget			
		5 ms	10 ms	20 ms	30 ms
Packet Success Rate	95 %	0,057	0,111	0,133	0,144
	99 %	0,017	0,093	0,126	0,138
	99.5 %	0,013	0,080	0,122	0,133
	99.9 %	0,003	0,053	0,115	0,127
	99.95 %	0,001	0,044	0,107	0,126

NOTE: Other system parameters are selected as in Figure B.5 (rainfall rate exceeded for 0,01 % of an average year = 145 mm/h), except for a peak-to-median ratio of the aggregated RAN traffic data rate process requested by the gNB = 3.

Figure B.9: Average Percentage Of Happy Users μ and BTA for the scenario of Figure B.1 with 100 % of users running VR DL services and for different Backhaul link lengths (0 km, 1,6 km, 4 km)

B.1.2.2 100 % Of RAN Wireless Users Running Cloud Gaming Downlink Services

In this clause, the focus is on the scenario depicted in Figure B.1 with 100 % of the active RAN wireless users running CG DL services, according to the statistical model described in clause B.1.1.2. Figures B.10 and B.11 show the Average Percentage Of Happy Users μ achieved by selecting different combinations of PDB (varying along the columns) and Packet Success Rate (varying along the rows) requirements for the *happy users* and by considering different Backhaul link lengths (0 km, 2,9 km or 1,6 km, and 7,7 km or 4,5 km) for an annual rainfall rate exceeded for 0,01 % of an average year equal to 60 mm/h and 145 mm/h, respectively. Also in Figures B.10 and B.11, table (a) explicitly reports the Average Percentage Of Happy Users μ achieved in the different scenarios, while tables (b) and (c) express the drop in the Average Percentages Of Happy Users with respect to table (a) in percentage points. The numbers of simultaneously active RAN wireless users and their associated probability mass function (see Figure B.4) have been selected so as to achieve a peak-to-median ratio of the aggregated RAN traffic data rate requested by the gNB equal to 2,8, with a peak traffic data rate value equal to 1 500 Mbit/s and with a maximum number of RAN users equal to 176 over the three cellular sectors (other system parameters have been chosen as in Figure B.5).

(a) Average % Of Happy Users

Backhaul link length = 0 km, BTA = 100 %

		Packet Delay Budget			
		5 ms	10 ms	20 ms	30 ms
Packet Success Rate	95 %	31,478 %	40,151 %	51,890 %	72,308 %
	99 %	21,846 %	36,277 %	43,376 %	56,246 %
	99.5 %	17,091 %	33,538 %	41,485 %	51,948 %
	99.9 %	10,476 %	28,243 %	38,730 %	44,703 %
	99.95 %	8,040 %	26,149 %	37,319 %	43,484 %

(b) Drop in Average % Of Happy Users with respect to (a) in percentage points

Backhaul link length = 2.9 km, BTA = 99.988 %

		Packet Delay Budget			
		5 ms	10 ms	20 ms	30 ms
Packet Success Rate	95 %	0,003	0,004	0,006	0,009
	99 %	0,002	0,004	0,005	0,007
	99.5 %	0,002	0,003	0,004	0,006
	99.9 %	0,001	0,002	0,004	0,005
	99.95 %	0,001	0,003	0,004	0,005

(c) Drop in Average % Of Happy Users with respect to (a) in percentage points

Backhaul link length = 7.7 km, BTA = 99.9 %

		Packet Delay Budget			
		5 ms	10 ms	20 ms	30 ms
Packet Success Rate	95 %	0,024	0,033	0,045	0,068
	99 %	0,018	0,028	0,038	0,053
	99.5 %	0,019	0,025	0,032	0,049
	99.9 %	0,016	0,012	0,029	0,036
	99.95 %	0,010	0,020	0,029	0,034

NOTE: Annual rainfall rate exceeded for 0,01 % of an average year = 60 mm/h; peak-to-median ratio of the aggregated RAN traffic data rate process requested by the gNB = 2,8; peak traffic data rate value = 1 500 Mbit/s (other system parameters as in Figure B.5).

Figure B.10: Average Percentage Of Happy Users μ and BTA for the scenario of Figure B.1 with 100 % of users running CG DL services and for different Backhaul link lengths (0 km, 2,9 km, 7,7 km)

As before, a Backhaul link length equal to 0 km refers to a scenario where the wireless Backhaul link experiences ideal propagation conditions and can deliver the maximum capacity of 1 803 Mbit/s with 100 % availability. Employing a traditional Backhaul planning criterion pursuing an availability requirement at least equal to 99,9 % for the maximum capacity (1 803 Mbit/s) and an availability requirement at least equal to 99,99 % for the minimum capacity (189 Mbit/s) would lead to a maximum achievable Backhaul link length equal to 2,9 km for 60 mm/h annual rainfall rate (Figure B.10) and equal to 1,6 km for 145 mm/h annual rainfall rate (Figure B.11). For all the tested combinations of PDB and Packet Success Rate requirements, the drop in the Average Percentage Of Happy Users μ keeps below 0,01 percentage points from a Backhaul link length of 0 km to 2,9 km and below 0,06 percentage points from 2,9 km to 7,7 km in Figure B.10, while it is below 0,02 percentage points from 0 km to 1,6 km and below 0,06 percentage points from 1,6 km to 4,5 km in Figure B.11. These results further corroborate the conclusion drawn in clause B.1.2.1 that even pushing the BTA requirement to more-than-double the achievable Backhaul distance with respect to the one obtained according to traditional planning criteria would lead to a negligible drop in the Average Percentage Of Happy Users.

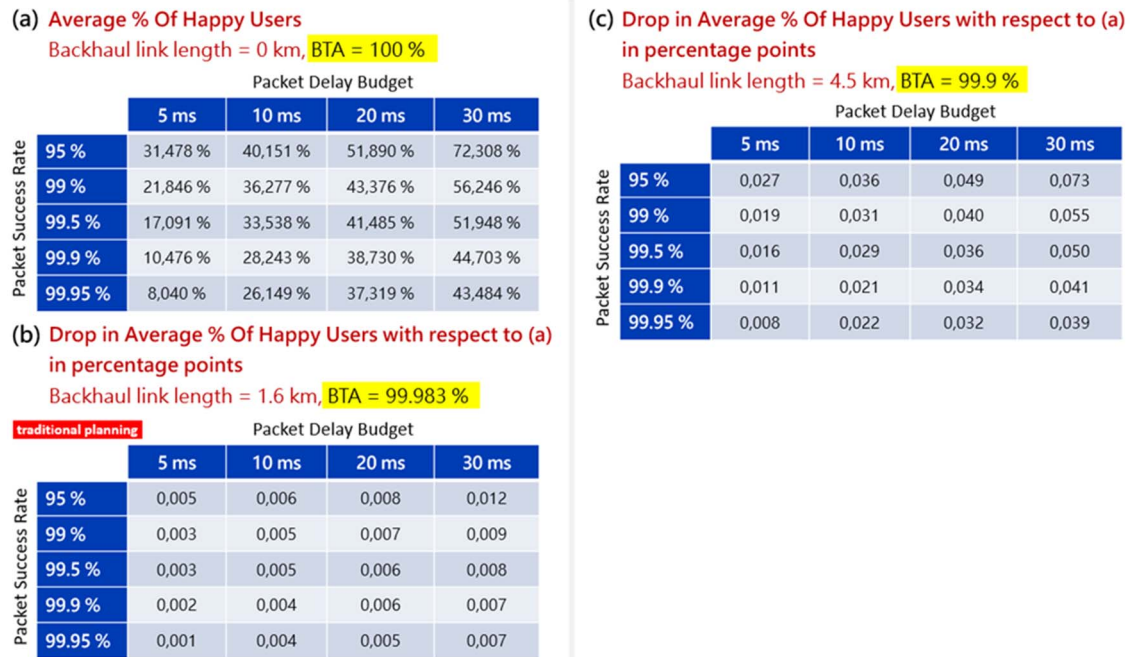

NOTE: Annual rainfall rate exceeded for 0,01 % of an average year = 145 mm/h; peak-to-median ratio of the aggregated RAN traffic data rate process requested by the gNB = 2,8; peak traffic data rate value = 1 500 Mbit/s (other system parameters as in Figure B.5).

Figure B.11: Average Percentage Of Happy Users μ and BTA for the scenario of Figure B.1 with 100 % of users running CG DL services and for different Backhaul link lengths (0 km, 1,6 km, 4,5 km)

B.1.2.3 Mixed Traffic (67 % VR DL Users + 33 % FTP DL Users)

In this clause, the focus is on the scenario depicted in Figure B.1 with 67 % of the active wireless users running VR DL services, according to the statistical model described in clause B.1.1.1, and 33 % of the active wireless users running FTP DL services, according to the statistical model described in clause B.1.1.3. Figures B.12 and B.13 show the Average Percentage Of Happy Users μ achieved by selecting different combinations of PDB (varying along the columns) and Packet Success Rate (varying along the rows) requirements for the *happy* VR DL users, while each FTP DL user is defined as *happy* if all the received packets experience an overall delay (over the cascade of the Backhaul and the RAN connections) lower than 0,6 seconds, according to the definition given in clause B.1.1.4 (i.e. Packet Success Rate = 100 % and PDB = 0,6 seconds). As before, table (a) explicitly reports the Average Percentage Of Happy Users μ achieved in the different scenarios, while tables (b) and (c) express the drop in the Average Percentages Of Happy Users with respect to table (a) in percentage points. Different Backhaul link lengths for an annual rainfall rate exceeded for 0,01 % of an average year equal to 60 mm/h (Figure B.12) and equal to 145 mm/h (Figure B.13) are outlined. The numbers of simultaneously active RAN wireless users and their associated probability mass function (see Figure B.4) have been selected so as to achieve a peak-to-median ratio of the aggregated RAN traffic data rate process requested by the gNB equal to 3,5 in both Figures B.12 and B.13, with a peak traffic data rate value equal to 2 025 Mbit/s and with a maximum number of RAN users over the three cellular sectors equal to 90 (other system parameters have been chosen as in Figure B.5). Notice that in scenario (a) of both Figures B.12 and B.13 the BTA value (that is here lower than 100 %) is uniquely determined by the probability that the aggregated RAN traffic data rate exceeds the highest capacity that can be delivered by the Backhaul link (equal to 1 803 Mbit/s).

(a) Average % Of Happy Users

Backhaul link length = 0 km, BTA = 99.997 %

		Packet Delay Budget			
		5 ms	10 ms	20 ms	30 ms
Packet Success Rate	95 %	13,097 %	44,082 %	56,826 %	63,103 %
	99 %	3,007 %	32,497 %	51,591 %	58,910 %
	99.5 %	1,549 %	28,755 %	49,668 %	56,694 %
	99.9 %	0,238 %	15,457 %	43,788 %	53,072 %
	99.95 %	0,033 %	11,751 %	41,679 %	51,193 %

(b) Drop in Average % Of Happy Users with respect to (a) in percentage points

Backhaul link length = 2.9 km, BTA = 99.983 %

		Packet Delay Budget			
		5 ms	10 ms	20 ms	30 ms
Packet Success Rate	95 %	0,003	0,008	0,010	0,011
	99 %	0,001	0,006	0,009	0,010
	99.5 %	0,000	0,006	0,008	0,009
	99.9 %	0,000	0,004	0,007	0,009
	99.95 %	0,000	0,003	0,008	0,008

(c) Drop in Average % Of Happy Users with respect to (a) in percentage points

Backhaul link length = 7.5 km, BTA = 99.9 %

		Packet Delay Budget			
		5 ms	10 ms	20 ms	30 ms
Packet Success Rate	95 %	0,026	0,055	0,069	0,078
	99 %	0,006	0,039	0,061	0,072
	99.5 %	0,003	0,044	0,058	0,059
	99.9 %	0,001	0,030	0,042	0,061
	99.95 %	0,000	0,027	0,056	0,057

NOTE: Annual rainfall rate exceeded for 0,01 % of an average year = 60 mm/h; peak-to-median ratio of the aggregated RAN traffic data rate process requested by the gNB = 3,5; peak traffic data rate value = 2 025 Mbit/s (other system parameters as in Figure B.5).

Figure B.12: Average Percentage Of Happy Users μ and BTA for the scenario of Figure B.1 with 67 % of users running VR DL services and 33 % of users running FTP DL services, for different Backhaul link lengths (0 km, 2,9 km, 7,5 km)

As before, a Backhaul link length equal to 0 km refers to a scenario where the wireless Backhaul link experiences ideal propagation conditions and can deliver the maximum capacity of 1 803 Mbit/s with 100 % availability. Employing a traditional Backhaul planning criterion pursuing an availability requirement at least equal to 99,9 % for the maximum capacity (1 803 Mbit/s) and an availability requirement at least equal to 99,99 % for the minimum capacity (189 Mbit/s) would lead to a maximum achievable Backhaul link length equal to 2,9 km for 60 mm/h annual rainfall rate (Figure B.12) and equal to 1,6 km for 145 mm/h annual rainfall rate (Figure B.13). For all the tested combinations of PDB and Packet Success Rate requirements for the *happy* VR DL wireless users, the drop in the Average Percentage Of Happy Users μ keeps below 0,01 percentage points from a Backhaul link length of 0 km to 2,9 km and below 0,07 percentage points from 2,9 km to 7,5 km in Figure B.12, while it is below 0,02 percentage points from 0 km to 1,6 km and below 0,06 percentage points from 1,6 km to 4,2 km in Figure B.13. These results further corroborate the conclusion drawn in clause B.1.2.1 that even pushing the BTA requirement to more-than-double the achievable Backhaul distance with respect to the one obtained according to traditional planning criteria would lead to a negligible drop in the Average Percentage Of Happy Users.

(a) Average % Of Happy Users

Backhaul link length = 0 km, BTA = 99.997 %

		Packet Delay Budget			
		5 ms	10 ms	20 ms	30 ms
Packet Success Rate	95 %	13,097 %	44,082 %	56,826 %	63,103 %
	99 %	3,007 %	32,497 %	51,591 %	58,910 %
	99.5 %	1,549 %	28,755 %	49,668 %	56,694 %
	99.9 %	0,238 %	15,457 %	43,788 %	53,072 %
	99.95 %	0,033 %	11,751 %	41,679 %	51,193 %

(b) Drop in Average % Of Happy Users with respect to (a) in percentage points

Backhaul link length = 1.6 km, BTA = 99.979 %

		Packet Delay Budget			
		5 ms	10 ms	20 ms	30 ms
Packet Success Rate	95 %	0,004	0,010	0,013	0,014
	99 %	0,001	0,008	0,011	0,013
	99.5 %	0,001	0,007	0,011	0,012
	99.9 %	0,000	0,004	0,009	0,012
	99.95 %	0,000	0,004	0,010	0,011

(c) Drop in Average % Of Happy Users with respect to (a) in percentage points

Backhaul link length = 4.2 km, BTA = 99.9 %

		Packet Delay Budget			
		5 ms	10 ms	20 ms	30 ms
Packet Success Rate	95 %	0,021	0,052	0,066	0,075
	99 %	0,005	0,039	0,059	0,069
	99.5 %	0,003	0,038	0,056	0,063
	99.9 %	0,001	0,024	0,047	0,060
	99.95 %	0,000	0,019	0,051	0,057

NOTE: Annual rainfall rate exceeded for 0,01 % of an average year = 145 mm/h; peak-to-median ratio of the aggregated RAN traffic data rate process requested by the gNB = 3,5; peak traffic data rate value = 2 025 Mbit/s (other system parameters as in Figure B.5).

Figure B.13: Average Percentage Of Happy Users μ and BTA for the scenario of Figure B.1 with 67 % of users running VR DL services and 33 % of users running FTP DL services, for different Backhaul link lengths (0 km, 1,6 km, 4,2 km)

B.2 BCA link backhauling three 5G NR sites: HD Video and Web browsing services

B.2.0 Introduction

This clause presents the simulations done in order to link Backhaul Traffic Availability (BTA) and user Quality of Experience (QoE). To achieve this, a realistic 5G RAN system is simulated. The simulation includes aspects such as traffic load, traffic type, user distribution, spectrum, propagation, interference, scheduling, etc. It considers a backhaul link that aggregates three 5G RAN sites in an urban deployment. Simulation tool takes three different RAN load levels and distribute video users and web browsing users in the 9 sectors. It then measures the QoE of each user separately. Then by plotting BTA and average QoE, it is possible drawing some conclusions on the recommended range of BTA values. In clause B.2.1, simulation setup is described in detail. In clause B.2.2, plots and results are provided. Conclusions can be found in clause B.2.3.

B.2.1 Simulation Models and Assumptions

B.2.1.0 Network scenario

Simulation scenario is a three-site aggregation as shown in Figure B.14. Each of the RAN sites is connected to the wireless backhaul aggregation link using fibre links. Hence in the simulation these links are ideal (non-limiting capacity which is always available). The wireless backhaul link carries thus the aggregated traffic of three sites, where each site consists of three sectors, and in total 9 sectors.

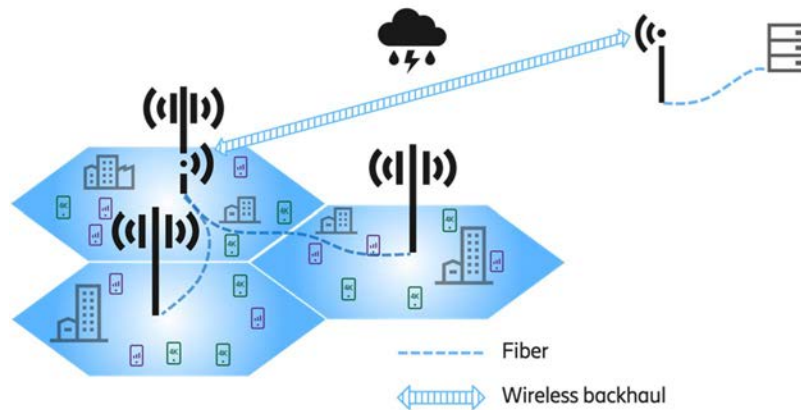

Figure B.14: Schematic of the simulation setup

B.2.1.1 Details of RAN

Simulation focuses on a standard 3GPP urban macro scenario [i.15] with 500 m inter site distance. The RAN operates at 3,5 GHz with 100 MHz bandwidth. Each base station has 16 antennas and the UEs have 4 antennas each. The base station is capable of doing single user MIMO with maximum 4 MIMO layers. The maximum modulation supported is 64QAM. The TDD pattern is such that the DL-to-UL frame ratio is 3:2.

Three RAN load levels are considered. These levels are determined by the corresponding RAN utilization values. 22 % utilization is considered to be low load, 52 % utilization to be medium load, and 76 % utilization to be high load. Simulations consider both video users and web browsing users. The video users are present throughout the whole simulation and are streaming HD video (12 Mbps average bandwidth). The web browsing users arrive randomly and download a file of 2MB. They disappear once the download is completed. The number of video users and the arrival rate of web browsing users are chosen to match the required RAN utilization values for the load levels. These numbers are given in Table B.3.

Table B.3: RAN traffic load levels and relevant number of users per service

Load level	# Video users per sector	Arrival rate of web browsing users per sector
Low load	3 video users	1,8 web users/second
Medium load	17 video users	2,2 web users/second
High load	22 video users	4 web users/second

B.2.1.2 Details of wireless backhaul link

The wireless backhaul link considered is a 6,92 km long Band-Carrier Aggregation (BCA) link. It has two components, a low band component running at 18 GHz and an E-band component. Both components have a 0,6 m antenna. The low band component has 56 MHz channel spacing and the E-band has 750 MHz channel spacing. The low band is fixed at the maximum transmit power possible for all modulations while the power setting of the E-band can be changed to find a suitable operating point.

B.2.1.3 Combined RAN and backhaul operation

Simulation tool simulates a steady state network operation for 45 seconds. To simulate video users at steady state, a preload 30 seconds of video at the start is assumed. The user QoE of video users is measured using Recommendation ITU-T P.1203 [i.16]. This QoE is a number between 1 and 5 (where 1 indicates a bad user experience and 5 indicates an excellent user experience) calculated as a function of different parameters as depicted in Figure B.15.

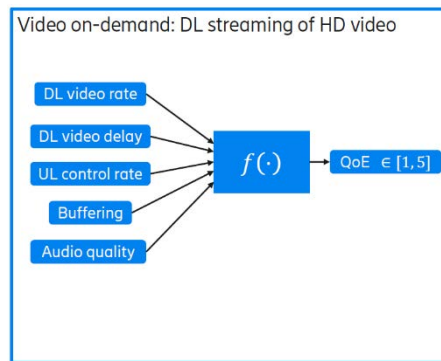

Figure B.15: Video streaming QoE measurement based on Recommendation ITU-T P.1203 [i.16]

The web browsing users arrive at a stipulated rate and requests for a file download of 2 MB. Based on the file download delay, the simulator assigns a number between 1 and 5 as per the curve shown in Figure B.16.

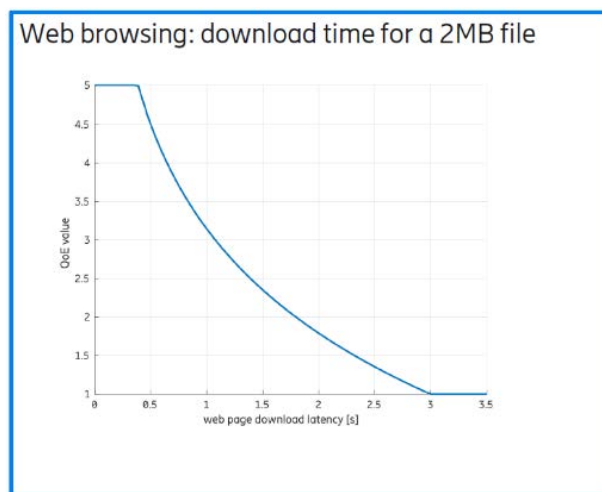

Figure B.16: Web browsing QoE measurement as function of 2 MB file download time

As mentioned, baseline is the simulation of network operation for 45 seconds, but significant fading events at the wireless backhaul link happens at a much larger time scale. So, the ideal solution would be to simulate a much larger network operation time (in the order of months). It is possible avoiding this humongous simulation task by using a semi-analytical approach consisting of:

- steady 45 seconds network simulation assuming that backhaul link has a fixed rate;
- different simulations for all backhaul link rate values possible;
- taking a weighted average of the QoE numbers to obtain an average QoE. The weights chosen for each backhaul link rate corresponds to the probability mass dictated by the availability calculations, see Recommendation ITU-R P.530-18 [i.5].

Thus, obtaining:

$$\overline{\text{QoE}} = \sum_R \mathbb{E}[\text{QoE}(R, \dots) \mid \text{link rate} = R] \Pr\{\text{link rate} = R\}$$

where $\mathbb{E}[\cdot]$ is the expectation operator and $\text{QoE}(R, \dots)$ represents the QoE of each user that is a function of the backhaul rate R along with a lot of other parameters. The probability mass function corresponding to each rate R that the backhaul can support is denoted as $\Pr\{\text{link rate} = R\}$ in the equation.

B.2.2 Numerical analysis

This clause presents and discusses the simulations results.

The aim is to find an ideal operating point for the wireless backhaul link such that its impact on user QoE is minimized. To define such an operating point, the traditional dimensioning method is used. The rate is dimensioned at the total expected rate from the RAN, and then the methodology tries to find the smallest availability number for this single rate number that has acceptable impact on user QoE. Once this is found, it is easy to find the corresponding transmit powers for all modulations. The sum rate from the RAN at 70 % utilization has been evaluated and it has been selected as the dimensioned rate. It turns out to be 1,38 Gbps. So, in most of the following plots the X-axis represents the availability for 1,38 Gbps link rate.

The availability plots corresponding to different configurations of the E-band component is shown in Figure B.17. As mentioned before, in both of those plots, the 18 GHz component is at maximum transmit power for all modulations. The maximum link capacity is 3,58 Gbps.

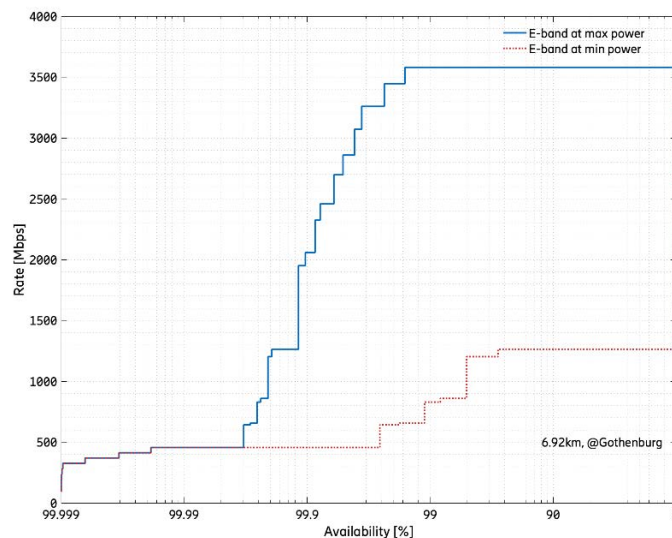

Figure B.17: Availability plots for the backhaul link

The combined RAN traffic for all sites at high load is shown in Figure B.18. It is obvious that keeping E-band at lowest transmit power (red line in Figure B.18), then the backhaul will be a significant bottleneck since the RAN traffic demand can never be satisfied. The CDF plots of the RAN traffic for the three different RAN loads are shown in Figure B.19.

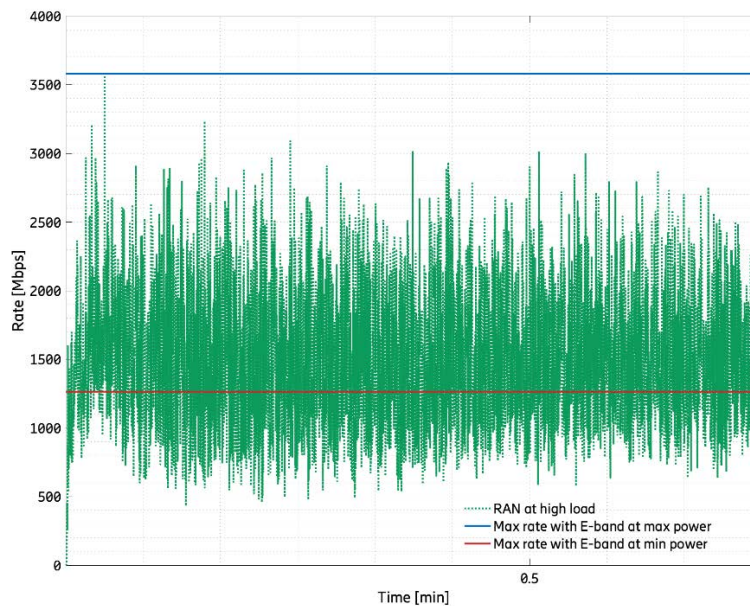

Figure B.18: RAN at high traffic load

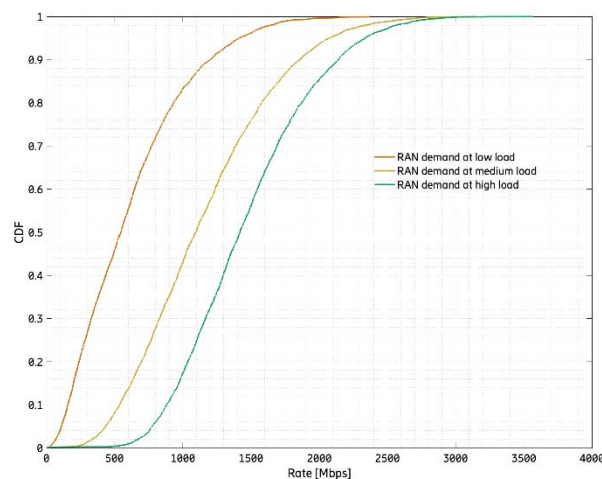

Figure B.19: CDF of RAN traffic for different loads

The QoE for web browsing users are shown in Figure B.20 (here the X-axis is availability for 1,38 Gbps). As expected, the higher the load, the lower the QoE. The QoE corresponding to ideal backhaul is marked using a circle (found on the left-hand side). Notice that even having ideal backhaul cannot offset the congestion caused by RAN at high load. This means that it is the RAN itself that is, independently of the backhaul, causing the non-ideal QoE. Congestion in the RAN is caused by fading, interference, etc., in the RBS-to-user layer. What is an acceptable reduction in QoE can be debated and may vary between different MNOs. Here for simplicity it has been chosen 0,01 as an acceptable offset from the maximum obtainable QoE. Using this simple backhaul dimensioning rule, the resulting availability for 1,38 Gbps should be at least 99,7 %.

The same analysis can be repeated using the QoE plots for video users given in Figure B.21. Video users being more tolerant to errors, require an even lower number of 93 % availability for 1,38 Gbps to satisfy the dimensioning rule. So, in order to satisfy both web browsing users and video users, it is necessary to select 99,7 % as the required availability for 1,38 Gbps.

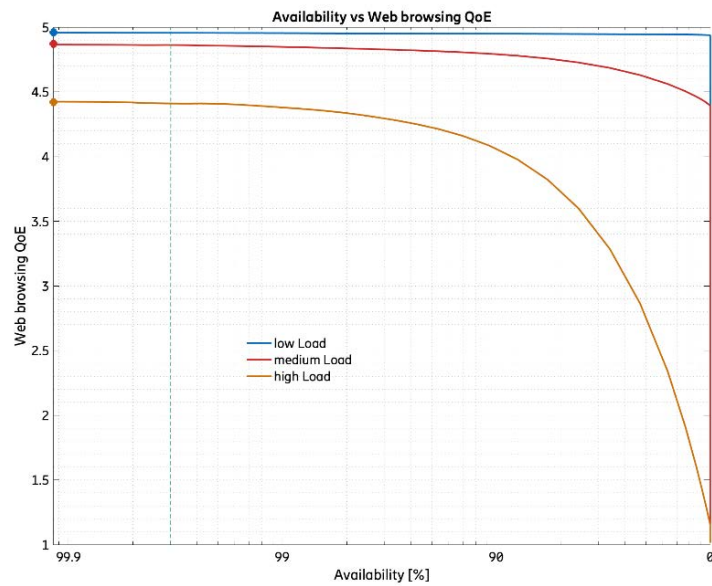

Figure B.20: Web user QoE

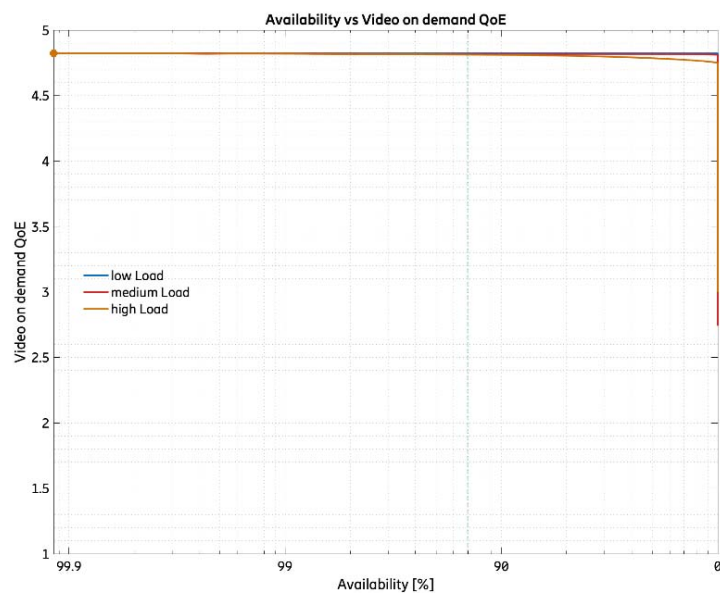

Figure B.21: Video user QoE

Using this dimensioning rule, it is now possible to connect back to BTA (defined in clause 6) and see how low it can be. To do this the BTA plots in Figure B.22 are provided as a function of the dimensioning rate availability. The BTA values are decreasing with increasing load, as expected. It can be observed that when 1,38 Gbps is assigned 99,7 % availability, the corresponding BTA for high load is 99,75 %. This means the BTA value can be as low as 99,75 %, and still the video users and web browsing users will have near-ideal QoE. The corresponding availability curve that guarantees this operating point is shown in Figure B.23.

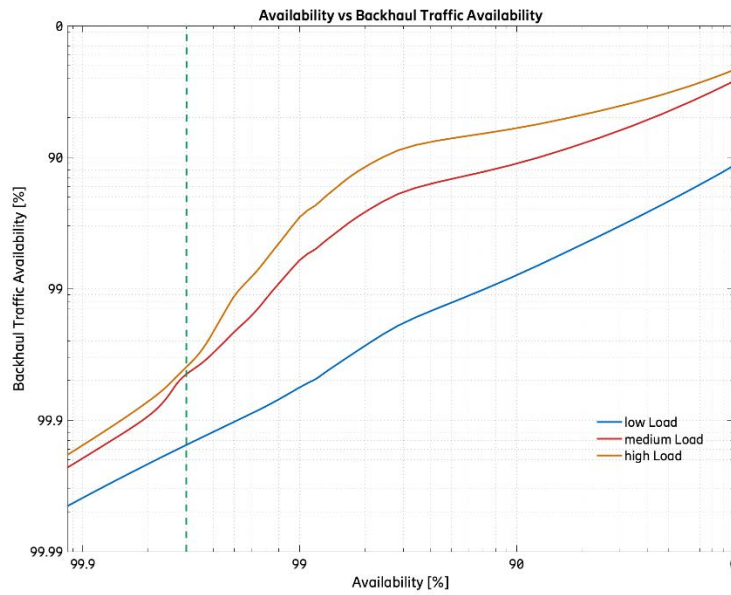

Figure B.22: Plot of BTA

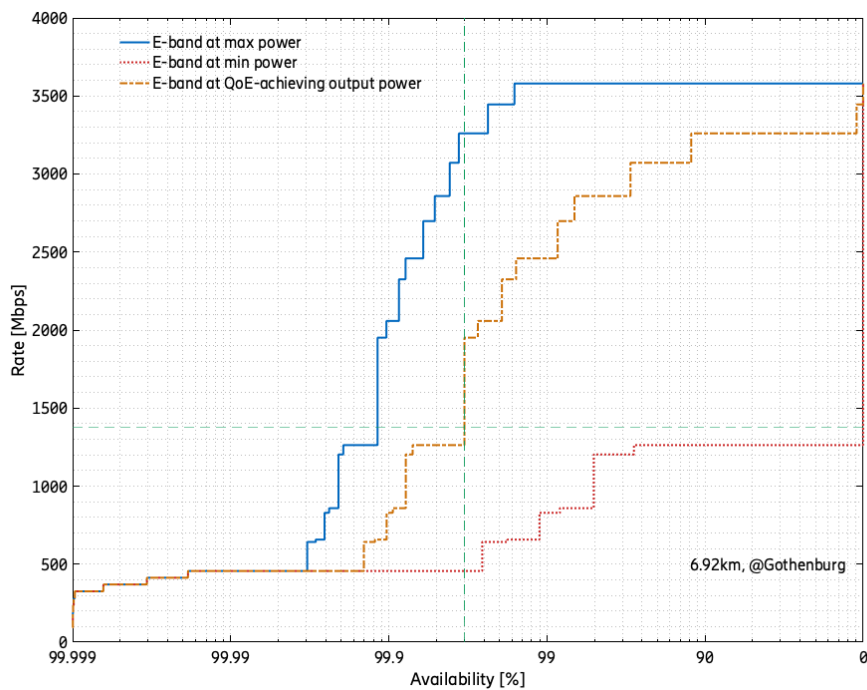

Figure B.23: Backhaul availability curve

Thus, it has been shown how to make use of combined RAN and backhaul simulations to dimension a wireless backhaul link that guarantees near-ideal QoE for the different user types and traffic loads. Notice that only two user types have been considered for now. By expanding this set it might be possible obtaining even stricter requirements on the BTA.

B.2.3 Conclusions

A new way to dimension backhaul has been presented, it considers realistic RAN-performance and user QoE for two different services. The evaluation was done using system-level simulations of an urban 5G NR deployment. When using this dimensioning method, it is possible understanding that traditional dimensioning guidelines can be less conservative without negative impact on user QoE. For example, near-ideal QoE is attained by dimensioning with 99,7 % availability of 1,38 Gbps where 1,38 Gbps corresponds to the average sum rate of the RAN at 70 % utilization. Different MNOs may have different requirements on user QoE, but it should be noted that it is possible to improve traditional backhaul dimensioning rules with no or minor impact on user QoE.

Annex C: Change History

Date	Version	Information about changes
October 2022	0.0.1	First early draft - output of Plenary #23
November 2022	0.0.2	Draft revision to put forward for Dec'22 on line meeting
January 2023	0.0.3	First stable draft for Plenary #24
February 2023	0.0.4	Final draft for approval
April 2023	1.1.1	First published version

History

Document history		
V1.1.1	April 2023	Publication