



## **Network Functions Virtualisation (NFV) Release 4; Protocols and Data Models; Specification of protocols and data models for Container Infrastructure Service Cluster Management**

### *Disclaimer*

---

The present document has been produced and approved by the Network Functions Virtualisation (NFV) ETSI Industry Specification Group (ISG) and represents the views of those members who participated in this ISG.  
It does not necessarily represent the views of the entire ETSI membership.

---

**Reference**

DGS/NFV-SOL020

---

**Keywords**

container, data models, MANO, NFV, protocol

**ETSI**

---

650 Route des Lucioles  
F-06921 Sophia Antipolis Cedex - FRANCE

Tel.: +33 4 92 94 42 00 Fax: +33 4 93 65 47 16

Siret N° 348 623 562 00017 - APE 7112B  
Association à but non lucratif enregistrée à la  
Sous-Préfecture de Grasse (06) N° w061004871

---

**Important notice**

The present document can be downloaded from:

<https://www.etsi.org/standards-search>

The present document may be made available in electronic versions and/or in print. The content of any electronic and/or print versions of the present document shall not be modified without the prior written authorization of ETSI. In case of any existing or perceived difference in contents between such versions and/or in print, the prevailing version of an ETSI deliverable is the one made publicly available in PDF format at [www.etsi.org/deliver](http://www.etsi.org/deliver).

Users of the present document should be aware that the document may be subject to revision or change of status.

Information on the current status of this and other ETSI documents is available at

<https://portal.etsi.org/TB/ETSIDeliverableStatus.aspx>

If you find errors in the present document, please send your comment to one of the following services:

<https://portal.etsi.org/People/CommitteeSupportStaff.aspx>

If you find a security vulnerability in the present document, please report it through our  
Coordinated Vulnerability Disclosure Program:

<https://www.etsi.org/standards/coordinated-vulnerability-disclosure>

---

**Notice of disclaimer & limitation of liability**

The information provided in the present deliverable is directed solely to professionals who have the appropriate degree of experience to understand and interpret its content in accordance with generally accepted engineering or other professional standard and applicable regulations.

No recommendation as to products and services or vendors is made or should be implied.

No representation or warranty is made that this deliverable is technically accurate or sufficient or conforms to any law and/or governmental rule and/or regulation and further, no representation or warranty is made of merchantability or fitness for any particular purpose or against infringement of intellectual property rights.

In no event shall ETSI be held liable for loss of profits or any other incidental or consequential damages.

Any software contained in this deliverable is provided "AS IS" with no warranties, express or implied, including but not limited to, the warranties of merchantability, fitness for a particular purpose and non-infringement of intellectual property rights and ETSI shall not be held liable in any event for any damages whatsoever (including, without limitation, damages for loss of profits, business interruption, loss of information, or any other pecuniary loss) arising out of or related to the use of or inability to use the software.

---

**Copyright Notification**

No part may be reproduced or utilized in any form or by any means, electronic or mechanical, including photocopying and microfilm except as authorized by written permission of ETSI.

The content of the PDF version shall not be modified without the written authorization of ETSI.

The copyright and the foregoing restriction extend to reproduction in all media.

© ETSI 2023.  
All rights reserved.

# Contents

Intellectual Property Rights .....	5
Foreword.....	5
Modal verbs terminology.....	5
1 Scope .....	6
2 References .....	6
2.1 Normative references .....	6
2.2 Informative references.....	6
3 Definition of terms, symbols and abbreviations.....	7
3.1 Terms.....	7
3.2 Symbols.....	7
3.3 Abbreviations .....	7
4 Overview .....	7
4.1 Summary of ETSI GS NFV-IFA 036.....	7
4.2 Summary of ETSI GS NFV-IFA 010.....	8
4.3 Profiled protocol and data model solution: Kubernetes® Cluster API.....	9
4.3.1 Introduction.....	9
4.3.2 API structure.....	9
4.3.3 Data model concepts.....	9
5 NFV object models mapping to profiled solution objects.....	10
5.1 CIS cluster object .....	10
5.2 CIS cluster node object.....	10
5.3 CISM instance object .....	10
6 CIS cluster lifecycle management service interface.....	11
6.1 Description .....	11
6.2 API version.....	11
6.3 Resource structure and methods.....	11
6.4 Sequence diagrams (informative).....	14
6.4.1 Introduction.....	14
6.4.2 Flow of creating a CIS cluster related NFV object.....	14
6.4.3 Flow of querying information about CIS cluster .....	15
6.4.4 Flow of modifying CIS cluster .....	16
6.4.4.1 Flow of modifying a CIS cluster related NFV object.....	16
6.4.4.2 Flow of replacing a CIS cluster related NFV object .....	17
6.4.5 Flow of deleting a CIS cluster related NFV object.....	17
6.5 Resources .....	18
6.5.1 Introduction.....	18
6.5.2 Resource: Cluster.....	18
6.5.3 Resource: Machine .....	19
6.5.4 Resource: MachineDeployment.....	19
6.5.5 Resource: MachineSet .....	20
6.5.6 Resource: MachinePool .....	21
6.5.7 Resource: KubeadmControlPlane.....	22
6.6 Data model .....	22
7 CIS cluster configuration management service interface.....	22
7.1 Description .....	22
7.2 API version.....	23
7.3 Resource structure and methods.....	23
7.4 Sequence diagrams (informative).....	25
7.5 Resources .....	25
7.5.1 Introduction.....	25
7.5.2 Resource: ClusterResourceSet .....	25
7.5.3 Resource: ClusterResourceSetBinding .....	25

7.5.4	Resource: KubeadmConfig.....	26
7.6	Data model .....	27
8	CIS cluster performance management service interface .....	27
9	CIS cluster fault management service interface .....	27
9.1	Description .....	27
9.2	API version.....	28
9.3	Resource structure and methods .....	28
9.4	Sequence diagrams (informative).....	29
9.5	Resources .....	29
9.5.1	Introduction.....	29
9.5.2	Resource: Cluster .....	29
9.5.3	Resource: Machine .....	30
9.5.4	Resource: MachineHealthCheck.....	31
9.6	Data model .....	31
10	CIS cluster security management service interface.....	32
10.1	Description .....	32
10.2	Features profiling .....	32
<b>Annex A (informative):</b>	<b>Analysis on the open-source solutions based on the CCM service interface requirements .....</b>	<b>33</b>
A.1	Kubernetes® Cluster API.....	33
A.1.1	Overview .....	33
A.1.2	Comparison of CCM service interface requirements and Kubernetes® Cluster API capabilities.....	33
A.1.3	Comparison of CCM functional requirements and Kubernetes® Cluster API capabilities.....	36
A.2	Terraform .....	38
A.2.1	Overview .....	38
A.2.2	Comparison of CCM service interface requirements and Terraform capabilities .....	39
A.2.3	Comparison of CCM functional requirements and Terraform capabilities .....	42
A.3	Kubespray.....	44
A.3.1	Overview .....	44
A.3.2	Comparison of CCM service interface requirements and Kubespray capabilities .....	44
A.3.3	Comparison of CCM functional requirements and Kubespray capabilities .....	48
A.4	Crossplane® .....	50
A.4.1	Overview .....	50
A.4.2	Comparison of CCM service interface requirements and Crossplane® capabilities .....	51
A.4.3	Comparison of CCM functional requirements and Crossplane® capabilities .....	54
A.5	OpenStack® Tacker .....	56
A.5.1	Overview .....	56
A.5.2	Comparison of CCM service interface requirements and OpenStack® Tacker capabilities .....	57
A.5.3	Comparison of CCM functional requirements and OpenStack® Tacker capabilities .....	60
A.5.4	Capabilities of Tacker to manage CIS cluster .....	62
A.5.4.1	Introduction.....	62
A.5.4.2	OpenStack® Tacker architecture .....	62
A.5.4.3	Managing VM based CIS cluster .....	64
A.5.4.4	Managing bare-metal CIS cluster .....	65
A.6	Comparison of the open-source solutions against the CCM service interface requirements .....	65
A.7	Comparison of the open-source solutions against the CCM functional requirements .....	67
<b>Annex B (informative):</b>	<b>The version supporting relationship between Cluster API and Kubernetes® .....</b>	<b>69</b>
<b>Annex C (informative):</b>	<b>Change History .....</b>	<b>70</b>
History .....		71

---

# Intellectual Property Rights

## Essential patents

IPRs essential or potentially essential to normative deliverables may have been declared to ETSI. The declarations pertaining to these essential IPRs, if any, are publicly available for **ETSI members and non-members**, and can be found in ETSI SR 000 314: "*Intellectual Property Rights (IPRs); Essential, or potentially Essential, IPRs notified to ETSI in respect of ETSI standards*", which is available from the ETSI Secretariat. Latest updates are available on the ETSI Web server (<https://ipr.etsi.org/>).

Pursuant to the ETSI Directives including the ETSI IPR Policy, no investigation regarding the essentiality of IPRs, including IPR searches, has been carried out by ETSI. No guarantee can be given as to the existence of other IPRs not referenced in ETSI SR 000 314 (or the updates on the ETSI Web server) which are, or may be, or may become, essential to the present document.

## Trademarks

The present document may include trademarks and/or tradenames which are asserted and/or registered by their owners. ETSI claims no ownership of these except for any which are indicated as being the property of ETSI, and conveys no right to use or reproduce any trademark and/or tradename. Mention of those trademarks in the present document does not constitute an endorsement by ETSI of products, services or organizations associated with those trademarks.

**DECT™**, **PLUGTESTS™**, **UMTS™** and the ETSI logo are trademarks of ETSI registered for the benefit of its Members. **3GPP™** and **LTE™** are trademarks of ETSI registered for the benefit of its Members and of the 3GPP Organizational Partners. **oneM2M™** logo is a trademark of ETSI registered for the benefit of its Members and of the oneM2M Partners. **GSM®** and the GSM logo are trademarks registered and owned by the GSM Association.

---

# Foreword

This Group Specification (GS) has been produced by ETSI Industry Specification Group (ISG) Network Functions Virtualisation (NFV).

---

# Modal verbs terminology

In the present document "**shall**", "**shall not**", "**should**", "**should not**", "**may**", "**need not**", "**will**", "**will not**", "**can**" and "**cannot**" are to be interpreted as described in clause 3.2 of the [ETSI Drafting Rules](#) (Verbal forms for the expression of provisions).

"**must**" and "**must not**" are **NOT** allowed in ETSI deliverables except when used in direct citation.

---

# 1 Scope

The present document specifies the service interfaces to fulfil the functional requirements of the container infrastructure service cluster management (CIS Cluster Management, or CCM in abbreviation) as specified by ETSI GS NFV-IFA 036. It analyses the NFV object model for CIS cluster management and the managed objects of the referenced open-source solutions (e.g. Kubernetes® cluster API) and provide a mapping between them. Based on the analysis results, the referenced solutions are profiled for specifying the CIS cluster lifecycle, configuration, performance, fault and security management service interfaces.

---

## 2 References

### 2.1 Normative references

References are either specific (identified by date of publication and/or edition number or version number) or non-specific. For specific references, only the cited version applies. For non-specific references, the latest version of the referenced document (including any amendments) applies.

Referenced documents which are not found to be publicly available in the expected location might be found at <https://docbox.etsi.org/Reference/>.

NOTE: While any hyperlinks included in this clause were valid at the time of publication, ETSI cannot guarantee their long term validity.

The following referenced documents are necessary for the application of the present document.

- [1] [ETSI GS NFV-IFA 036](#): "Network Functions Virtualisation (NFV) Release 4; Management and Orchestration; Requirements for service interfaces and object model for container cluster management and orchestration specification".
- [2] [Kubernetes® Cluster API v1.5](#).
- [3] [Kubernetes® API v1.27](#).
- [4] [ETSI GS NFV-IFA 040](#): "Network Functions Virtualisation (NFV) Release 4; Management and Orchestration; Requirements for service interfaces and object model for OS container management and orchestration specification".
- [5] Kubernetes®: "[API Access Control](#)".
- [6] Kubernetes®: "[Auditing](#)".

### 2.2 Informative references

References are either specific (identified by date of publication and/or edition number or version number) or non-specific. For specific references, only the cited version applies. For non-specific references, the latest version of the referenced document (including any amendments) applies.

NOTE: While any hyperlinks included in this clause were valid at the time of publication, ETSI cannot guarantee their long term validity.

The following referenced documents are not necessary for the application of the present document but they assist the user with regard to a particular subject area.

- [i.1] ETSI GR NFV 003: "Network Functions Virtualisation (NFV); Terminology for Main Concepts in NFV".
- [i.2] ETSI GS NFV-SOL 002: "Network Functions Virtualisation (NFV) Release 4; Protocols and Data Models; RESTful protocols specification for the Ve-Vnfm Reference Point".

- [i.3] ETSI GS NFV-SOL 003 "Network Functions Virtualisation (NFV) Release 4; Protocols and Data Models; RESTful protocols specification for the Or-Vnfm Reference Point".
- [i.4] ETSI GS NFV-IFA 010: "Network Functions Virtualisation (NFV) Release 4; Management and Orchestration; Functional requirements specification".
- [i.5] OpenStack® Tacker: "[Virtualized Network Function Lifecycle Management Interface \(VNF LCM\)](#)".
- NOTE: Based on ETSI GS NFV-SOL 003 V3.3.1.
- [i.6] OpenStack® Tacker: "[Virtualized Network Function Performance Management Interface \(VNF PM\)](#)".
- NOTE: Based on ETSI GS NFV-SOL 003 V3.3.1.
- [i.7] OpenStack® Tacker: "[Virtualized Network Function Fault Management Interface \(VNF FM\)](#)".
- NOTE: Based on ETSI GS NFV-SOL 003 V3.3.1.
- [i.8] Kubernetes® documentation: "[Kubeadm](#)".
- [i.9] OpenStack®: "[Tacker User Guide](#)".
- [i.10] [ETSI GS NFV-SOL 014](#): "Network Functions Virtualisation (NFV) Release 4; Protocols and Data Models; YAML data model specification for descriptor-based virtualised resource management".

## 3 Definition of terms, symbols and abbreviations

### 3.1 Terms

For the purposes of the present document, the terms given in ETSI GR NFV 003 [i.1] apply.

### 3.2 Symbols

Void.

### 3.3 Abbreviations

For the purposes of the present document, the abbreviations given in ETSI GR NFV 003 [i.1] and the following apply:

NOTE: An abbreviation defined in the present document takes precedence over the definition of the same abbreviation, if any, in ETSI GR NFV 003 [i.1].

CCM	CIS Cluster Management
RBAC	Role Based Access Control

## 4 Overview

### 4.1 Summary of ETSI GS NFV-IFA 036

ETSI GS NFV-IFA 036 [1] specifies the requirements on CIS cluster management service interfaces provided by the CCM function:

- 1) CIS cluster lifecycle management.
- 2) CIS cluster configuration management.

- 3) CIS cluster performance management.
- 4) CIS cluster fault management.
- 5) CIS cluster security management.

Lifecycle management of CIS clusters produced by the CCM includes creating, modifying, deleting and querying CIS clusters, as well as sending notifications about changes related to CIS clusters when consumer's subscribed events occur. CIS clusters can be based on virtualised or physical compute resources. CCM is able to manage virtual, bare-metal and hybrid CIS clusters.

Configuration management for the CIS cluster is produced by the CCM to its consumers during the lifecycle of the CIS cluster. The configuration management operations include transferring and applying configuration information to the CIS cluster, querying the configuration of the CIS cluster and subscribing/notifying the events in case of the change of CIS cluster configurations.

The CIS cluster performance management is produced by the CCM to enable its consumers to collect performance information on a given CIS cluster related object instance. The performance information results from performance information of the virtualised resources that is collected from the VIM or performance information of bare-metal resources that is collected from a management entity managing physical resources, and mapped by the CCM to this CIS cluster related object instance.

The CIS cluster fault management is produced by the CCM to enable its consumers to collect CIS cluster fault information. Virtualised resource alarms or physical resource alarms collected by the CCM will be filtered and correlated by the CCM and mapped to the corresponding CIS cluster related object instances (e.g. CIS cluster node, storage or network), resulting in alarms on corresponding CIS cluster.

Security management for the CIS cluster is produced by the CCM to its consumers. CCM is able to guarantee secure communication among CIS cluster nodes, authenticate and authorize invoking CISM capabilities from external and/or internal entities of CIS cluster by using configuration files and declarative descriptors representing Role Based Access Control (RBAC) related information, and enable and configure the auditing of CIS cluster nodes.

## 4.2 Summary of ETSI GS NFV-IFA 010

ETSI GS NFV-IFA 010 [i.4] specifies that the following statements on the scope of the CCM function, part of NFV-MANO, applies to all CCM related requirements:

- The CCM is responsible for the deployment, monitoring and lifecycle management of CIS clusters, the lifecycle management of CISM instances of the CIS cluster, and allocation of instantiated infrastructure resources for CIS cluster nodes.
- The CCM is responsible for the lifecycle management of MCCO for a CIS cluster, interacting directly with the CIS cluster nodes or via the CISM.
- The CCM exposes corresponding APIs to its consumers and translates incoming request into operations which are enforced towards the required actions to the CIS cluster.
- The CCM is further responsible to use information from declarative descriptors and configuration files of the CIS cluster.

The functional requirements on the CCM function are grouped into requirements per CCM management service:

- CIS cluster lifecycle;
- resource;
- configuration;
- descriptor;
- fault;
- performance; and



- capacity management.

According to the ETSI GS NFV-IFA 010 [i.4], more detailed information about the CCM services and the CIS cluster NFV object model is provided in ETSI GS NFV-IFA 036 [1].

## 4.3 Profiled protocol and data model solution: Kubernetes® Cluster API

### 4.3.1 Introduction

This clause provides an overview over the Kubernetes® Cluster API (Cluster API, or CAPI in abbreviation) which is profiled against the requirements of the CCM service interfaces as specified by ETSI GS NFV-IFA 036 [1]. The overview covers the high-level API structure as well as the concepts for the data model of the managed resource objects.

### 4.3.2 API structure

Kubernetes® Cluster API [2] is a Kubernetes® sub-project focused on providing declarative APIs and tooling to simplify provisioning, upgrading, and operating multiple Kubernetes® clusters. Started by the Kubernetes® Special Interest Group (SIG) Cluster Lifecycle as a Kubernetes® add-on project, Cluster API also uses Kubernetes®-style APIs and follows Kubernetes® basic patterns to leverage standard RESTful terminology to describe the API concepts:

- A **resource type** is the name used in the URL.
- All resource types have a representation in JSON (their object schema) which is called a **kind**.
- A list of instances of a resource type is known as a **collection**.
- A single instance of a resource type is called a **resource**, and also usually represents an **object**.

All resource types are either scoped by the CIS cluster (e.g. `/apis/GROUP/VERSION/*`) or to a namespace (e.g. `/apis/GROUP/VERSION/namespaces/NAMESPACE/*`).

The Kubernetes® API [3] supports read and write operations on the Kubernetes® resource objects via a Kubernetes® API endpoint. A **custom resource** is an extension of the Kubernetes® API that is not necessarily available in a default Kubernetes® installation. The Cluster API project defines a series of custom resource objects to automate cluster lifecycle management.

Standard HTTP methods POST, PUT, PATCH, and DELETE support single resource (or custom resource) only. These methods with single resource (or custom resource) support have no support for submitting multiple resources (or custom resources) together in an ordered or unordered list or transaction.

A mapping of the Cluster API managed custom resource objects to the NFV object models is provided in clause 5 of the present document.

### 4.3.3 Data model concepts

Following Kubernetes® [3] pattern for resource objects, the Cluster API managed custom resource objects are modelled with individual object schemas. All custom resource objects defined in Cluster API project typically have three components:

- **Custom Resource ObjectMeta:** The metadata about the Cluster API managed custom resource object, such as its name, type, API version, annotations, and labels. This schema, which is common to all Kubernetes® resource and custom resource types, contains fields that may be updated both by the external user and the Cluster API.
- **Custom Resource Spec:** Defined by the external user and describes the desired state of the system concerning the Cluster API managed custom resource object. Specified when creating or modifying a Cluster API managed custom resource object is requested.

- **Custom Resource Status:** Provided by the Cluster API and represents the current state of the system concerning the Cluster API managed custom resource object.

## 5 NFV object models mapping to profiled solution objects

### 5.1 CIS cluster object

Selected Kubernetes® Cluster API custom resource object is identified to map to the CIS cluster object of the NFV object model, see clauses 4.2 and 5.1 in ETSI GS NFV-IFA 036 [1]. Table 5.1-1 lists the Kubernetes® Cluster API custom resource objects which is mapped to the NFV CIS cluster object type.

**Table 5.1-1: CAPI custom resource object mapped to NFV CIS cluster object**

CAPI custom resource object kind	CAPI custom resource URI	CAPI custom resource object description
Cluster	/apis/cluster.x-k8s.io/v1beta1/clusters	Represents a Kubernetes® cluster with necessary configuration parameters. A Kubernetes® cluster is a grouping of Nodes. Kubernetes® could orchestrate containerized workload on these Nodes.

### 5.2 CIS cluster node object

Selected Kubernetes® Cluster API custom resource objects are identified to map to the CIS cluster node object of the NFV object model, see clauses 4.2 and 5.1 in ETSI GS NFV-IFA 036 [1]. Table 5.2-1 lists the Kubernetes® Cluster API custom resource objects which are mapped to the NFV CIS cluster node object type.

**Table 5.2-1: CAPI custom resource objects mapped to NFV CIS cluster node object**

CAPI custom resource object kind	CAPI custom resource URI	CAPI custom resource object description
Machine	/apis/cluster.x-k8s.io/v1beta1/machines	Represents an infrastructure component hosting a Kubernetes® Node (for example, a Virtual Machine (VM) or a Bare-Metal (BM) server).
MachineDeployment	/apis/cluster.x-k8s.io/v1beta1/machinedeployments	Represents a set of Machines
MachineSet	/apis/cluster.x-k8s.io/v1beta1/machinesets	Represents a stable set of Machines

### 5.3 CISM instance object

Selected Kubernetes® Cluster API custom resource object is identified to map to the CISM instance object of the NFV object model, see clauses 4.2 and 5.1 in ETSI GS NFV-IFA 036 [1].

The CISM function offers OS container management services as described in ETSI GS NFV-IFA 040 [4]. A CIS cluster has one or more instances of the CISM which manages workloads deployed in its CIS cluster. The CISM instance is also responsible for managing the CIS instances. A CIS cluster has at least one CIS cluster node hosting a CIS instance and one CISM instance for the management [1].

In Kubernetes® Cluster API, the **control plane** is mapped to the NFV CISM instance object. The control plane in CAPI is a set of components that serve the Kubernetes® API [2]. In CAPI, Kubeadm [i.8] is used to bootstrap the control plane in the default method [2]. Table 5.3-1 lists the Kubernetes® Cluster API custom resource object which is mapped to the NFV CISM instance object type.

**Table 5.3-1: CAPI custom resource object mapped to NFV CISM instance object**

CAPI custom resource object kind	CAPI custom resource URI	CAPI custom resource object description
KubeadmControlPlane	/apis/controlplane.cluster.x-k8s.io/v1beta1/kubeadmcontrolplanes	Represents a set of components that serve the Kubernetes® API, which is bootstrapped by Kubeadm. (see note)
NOTE: In CAPI, Kubeadm is not the only way for bootstrapping the control plane. Providers could provide their own kind of control plane instead of the default CAPI custom resource object KubeadmControlPlane. Other kind of control plane (than KubeadmControlPlane) may have dependency on specific deployment environment.		

## 6 CIS cluster lifecycle management service interface

### 6.1 Description

This interface allows the API consumer to invoke CIS cluster lifecycle management operations towards the API producer. Kubernetes® Cluster API custom resource objects identified as CIS cluster related NFV objects (e.g. CIS cluster object, CIS cluster node object, and CISM instance object) are listed in clause 5 of the present document.

The operations provided through this interface are:

- Create CIS cluster.
- Query information about CIS cluster.
- Modify CIS cluster.
- Delete CIS cluster.
- Send notifications in the event of changes to a CIS cluster.

NOTE: ETSI GS NFV-IFA 036 [1] specifies that the CCM requests the NFVO to grant the process of resource management. This granting operation is not supported by the profiled solution CAPI, which is recognized as a gap in the analysis in the present document.

### 6.2 API version

The API {VERSION} for the profiled Kubernetes® Cluster API [2] custom resource objects identified as CIS cluster related NFV objects shall be set to "v1beta1". Details on the API structure are specified in clause 4.3.2 of the present document.

The corresponding Kubernetes® Cluster API roots are specified as:

`/apis/cluster.x-k8s.io/v1beta1`

`/apis/controlplane.cluster.x-k8s.io/v1beta1`

### 6.3 Resource structure and methods

Figures 6.3-1, 6.3-2, 6.3-3 and 6.3-4 show the overall resource URI structures for the profiled Kubernetes® Cluster API [2] for the CIS cluster lifecycle management service interface.

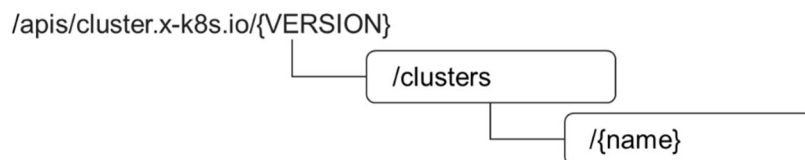

**Figure 6.3-1: Resource URI structure of Cluster resource object for the CIS cluster lifecycle management service interface**

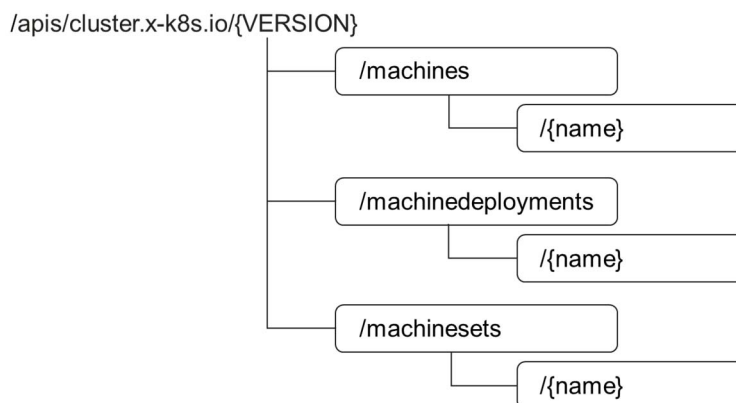

**Figure 6.3-2: Resource URI structure of Machine, MachineDeployment and MachineSet resource objects for the CIS cluster lifecycle management service interface**

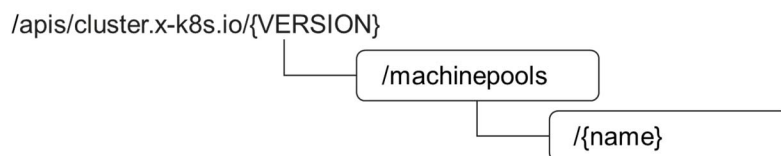

**Figure 6.3-3: Resource URI structure of MachinePool resource objects for the CIS cluster lifecycle management service interface**

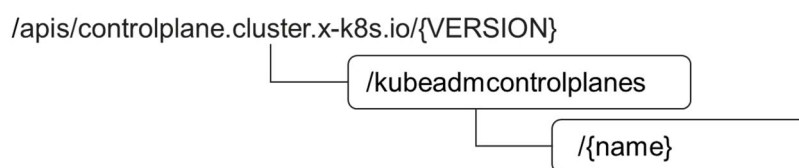

**Figure 6.3-4: Resource URI structure of KubeadmControlPlane resource object for the CIS cluster lifecycle management service interface**

Table 6.3-1 lists the individual resources defined, and the applicable HTTP methods.

The CCM supports responding to requests for all HTTP methods on the resources in Table 6.3-1 that are marked as "M" (mandatory) in the "Cat" column.

**Table 6.3-1: Resources and methods overview of the CIS cluster lifecycle management service interface**

Resource name	Resource URI	HTTP Method	Cat	Meaning
Cluster	/clusters	GET	M	List multiple Cluster instances.
		POST	M	Create a new "Individual Cluster instance" resource.

Resource name	Resource URI	HTTP Method	Cat	Meaning
Individual Cluster instance	/clusters/{name}	GET	M	Get information about the desired and actual state of an "Individual Cluster instance" resource.
		PATCH	M	Modify the desired or actual state of an "Individual Cluster instance" resource.
		PUT	M	Replace an "Individual Cluster instance" resource.
		DELETE	M	Delete an "Individual Cluster instance" resource.
Machine	/machines	GET	M	List multiple Machine instances.
		POST	M	Create a new "Individual Machine instance" resource.
Individual Machine instance	/machines/{name}	GET	M	Get information about the desired and actual state of an "Individual Machine instance" resource.
		PATCH	M	Modify the desired or actual state of an "Individual Machine instance" resource.
		PUT	M	Replace an "Individual Machine instance" resource.
		DELETE	M	Delete an "Individual Machine instance" resource.
MachineDeployment	/machinedeployments	GET	M	List multiple MachineDeployment instances.
		POST	M	Create a new "Individual MachineDeployment instance" resource.
Individual MachineDeployment instance	/machinedeployments/{name}	GET	M	Get information about the desired and actual state of an "Individual MachineDeployment instance" resource.
		PATCH	M	Modify the desired or actual state of an "Individual MachineDeployment instance" resource.
		PUT	M	Replace an "Individual MachineDeployment instance" resource.
		DELETE	M	Delete an "Individual MachineDeployment instance" resource.
MachineSet	/machinesets	GET	M	List multiple MachineSet instances.
		POST	M	Create a new "Individual MachineSet instance" resource.
Individual MachineSet instance	/machinesets/{name}	GET	M	Get information about the desired and actual state of an "Individual MachineSet instance" resource.
		PATCH	M	Modify the desired or actual state of an "Individual MachineSet instance" resource.
		PUT	M	Replace an "Individual MachineSet instance" resource.
		DELETE	M	Delete an "Individual MachineSet instance" resource.
MachinePool	/machinepools	GET	M	List multiple MachinePool instances.
		POST	M	Create a new "Individual MachinePool instance" resource.

Resource name	Resource URI	HTTP Method	Cat	Meaning
Individual MachinePool instance	/machinepools/{name}	GET	M	Get information about the desired and actual state of an "Individual MachinePool instance" resource.
		PATCH	M	Modify the desired or actual state of an "Individual MachinePool instance" resource.
		PUT	M	Replace an "Individual MachinePool instance" resource.
		DELETE	M	Delete an "Individual MachinePool instance" resource.
KubeadmControlPlane	/kubeadmcontrolplanes	GET	M	List multiple KubeadmControlPlane instances.
		POST	M	Create a new "Individual KubeadmControlPlane instance" resource.
Individual KubeadmControlPlane instance	/kubeadmcontrolplanes/{name}	GET	M	Get information about the desired and actual state of an "Individual KubeadmControlPlane instance" resource.
		PATCH	M	Modify the desired or actual state of an "Individual KubeadmControlPlane instance" resource.
		PUT	M	Replace an "Individual KubeadmControlPlane instance" resource.
		DELETE	M	Delete an "Individual KubeadmControlPlane instance" resource.

## 6.4 Sequence diagrams (informative)

### 6.4.1 Introduction

The sequence diagrams provided in the subsequent sub-clauses are generalized so that they apply to all Kubernetes® Cluster API custom resource objects identified as CIS cluster related NFV objects (e.g. CIS cluster object, CIS cluster node object, and CISM instance object).

The diagrams and their description contain placeholders indicated as <CIS cluster related NFV objects> which need to be replaced by the applicable CAPI custom resource name as listed in clause 6.3.

### 6.4.2 Flow of creating a CIS cluster related NFV object

This clause describes a sequence for creating an individual CIS cluster related NFV object.

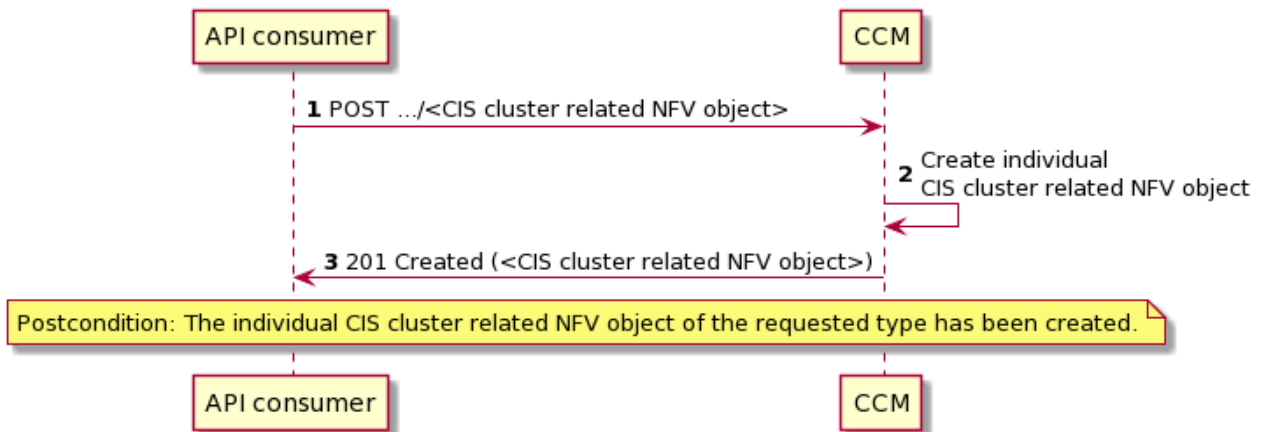

**Figure 6.4.2-1: Flow of creating a CIS cluster related NFV object**

The creation of a CIS cluster related NFV object (e.g. CIS cluster object, CIS cluster node object, and CISM instance object), as illustrated in figure 6.4.2-1, consists of the following steps.

**Precondition:** none.

- 1) The API consumer sends a POST request to the CCM with the appropriate <CIS cluster related NFV object> resource URI, including the data structure of the declarative descriptor of the respective CAPI custom resource object in the payload body.
- 2) The CCM creates an individual CIS cluster related NFV object.
- 3) The CCM returns a "201 Created" response to the API consumer and includes in the payload body a representation of the created <CIS cluster related NFV object>.

**Postcondition:** Upon successful completion, the individual CIS cluster related NFV object of the requested type has been created.

**Error handling:** In case of failure, appropriate error information is provided in the response.

### 6.4.3 Flow of querying information about CIS cluster

This clause describes a sequence for querying information about CIS cluster related NFV objects.

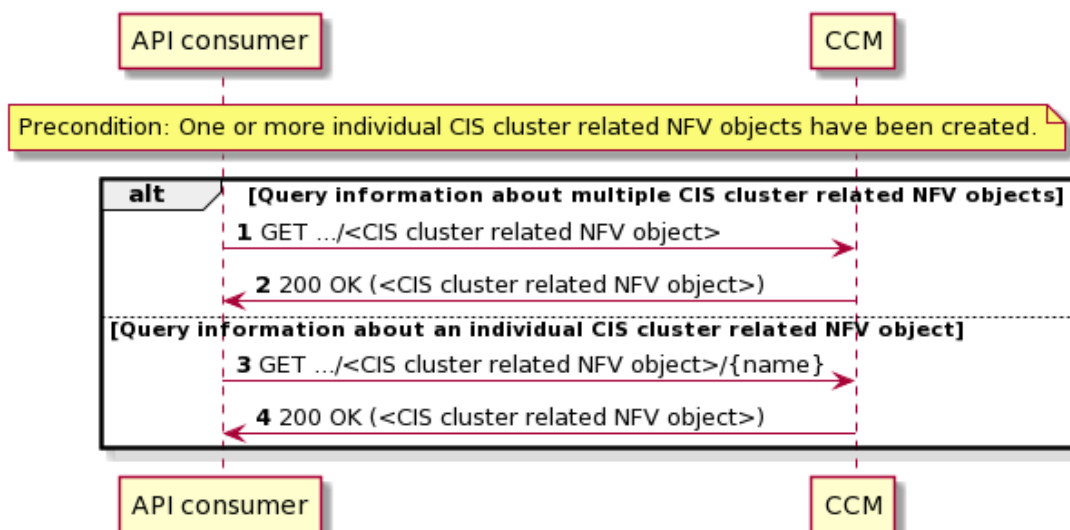

**Figure 6.4.3-1: Flow of querying information about one or more CIS cluster related NFV objects**

The querying information about one or more CIS cluster related NFV objects, as illustrated in figure 6.4.3-1, consists of the following steps.

**Precondition:** One or more individual CIS cluster related NFV objects have been created.

- 1) If the API consumer intends to query information about multiple CIS cluster related NFV objects, it sends CCM a GET request with the appropriate <CIS cluster related NFV object> resource URI.
- 2) The CCM returns a "200 OK" response to the API consumer and includes in the payload body a list of information about the CIS cluster related NFV objects.
- 3) If the API consumer intends to query information about an individual CIS cluster related NFV object, it sends a GET request for the individual <CIS cluster related NFV object> identified by its name in the URI.
- 4) The CCM returns a "200 OK" response to the API consumer and includes in the payload body a representation of information about the individual CIS cluster related NFV object.

**Postcondition:** none.

**Error handling:** In case of failure, appropriate error information is provided in the response.

## 6.4.4 Flow of modifying CIS cluster

### 6.4.4.1 Flow of modifying a CIS cluster related NFV object

This clause describes a sequence for modifying the desired or actual state of an individual CIS cluster related NFV object in CIS cluster modification operation.

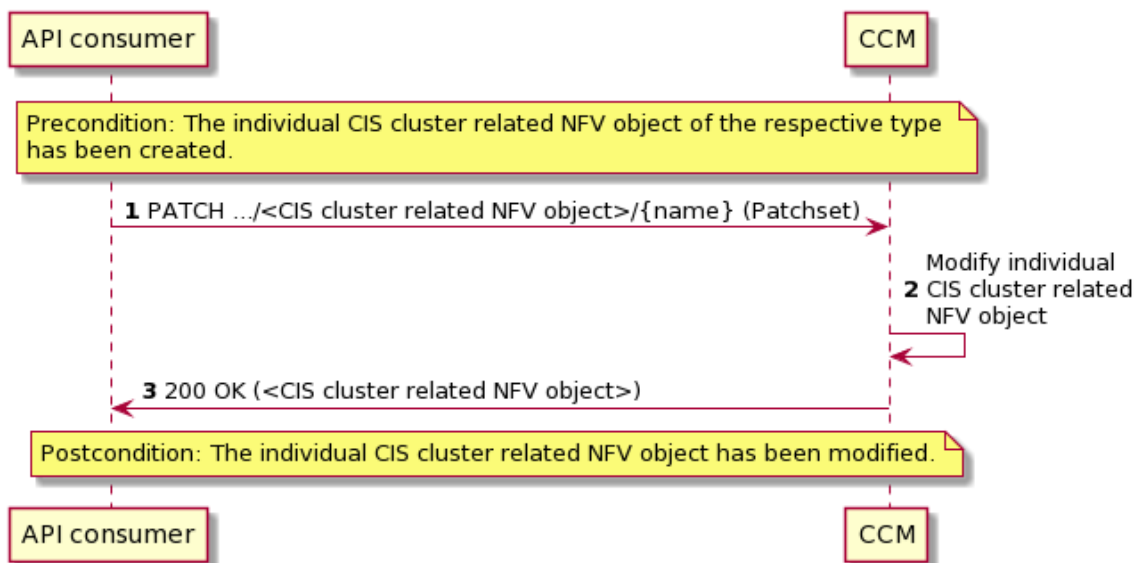

**Figure 6.4.4.1-1: Flow of modifying a CIS cluster related NFV object**

The modification of the desired or actual state of an individual CIS cluster related NFV object, as illustrated in figure 6.4.4.1-1, consists of the following steps.

**Precondition:** The individual CIS cluster related NFV object of the respective type has been created.

- 1) The API consumer sends a PATCH request for the individual <CIS cluster related NFV object> identified by its name in the URI, including the data structure representing the Patchset with the properties of the desired or actual state to be modified in the payload body.
- 2) The CCM modifies the individual CIS cluster related NFV object.
- 3) The CCM returns a "200 OK" response to the API consumer and includes in the payload body a representation of the modified <CIS cluster related NFV object> resource.



**Postcondition:** Upon successful completion, the desired or actual state of the individual CIS cluster related NFV object has been modified.

**Error handling:** In case of failure, appropriate error information is provided in the response.

#### 6.4.4.2 Flow of replacing a CIS cluster related NFV object

This clause describes a sequence for replacing an individual CIS cluster related NFV object in CIS cluster modification operation.

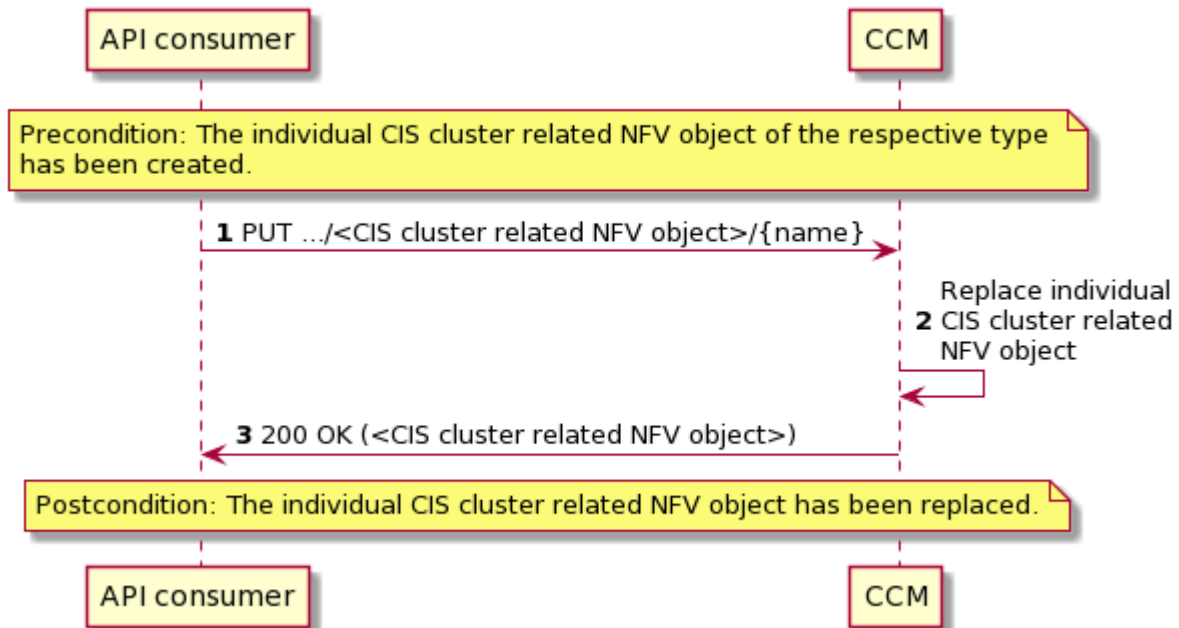

**Figure 6.4.4.2-1: Flow of replacing a CIS cluster related NFV object**

The replacement of an individual CIS cluster related NFV object, as illustrated in figure 6.4.4.2-1, consists of the following steps.

**Precondition:** The individual CIS cluster related NFV object of the respective type has been created.

- 1) The API consumer sends a PUT request for the individual <CIS cluster related NFV object> identified by its name in the URI, including the data structure of the replacing declarative descriptor of the respective CAPI custom resource in the payload body.
- 2) The CCM replaces the individual CIS cluster related NFV object.
- 3) The CCM returns a "200 OK" response to the API consumer and includes in the payload body a representation of the replacing <CIS cluster related NFV object>.

**Postcondition:** Upon successful completion, the individual CIS cluster related NFV object has been replaced.

**Error handling:** In case of failure, appropriate error information is provided in the response.

#### 6.4.5 Flow of deleting a CIS cluster related NFV object

This clause describes a sequence for deleting an individual CIS cluster related NFV object.

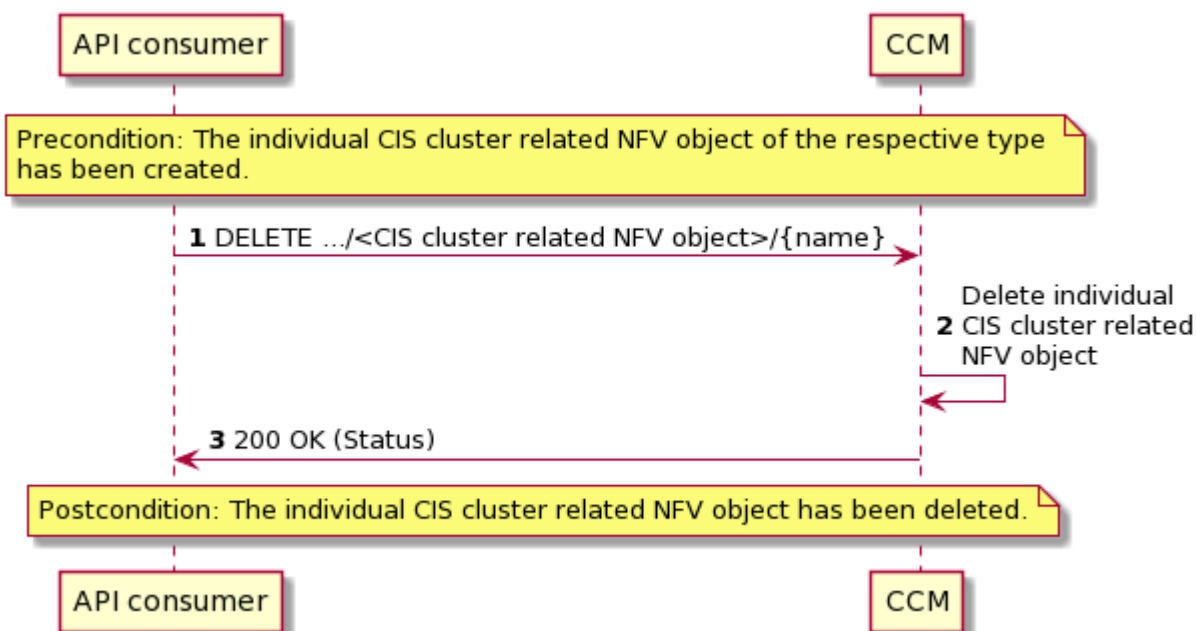

**Figure 6.4.5-1: Flow of deleting a CIS cluster related NFV object**

The deletion of an individual deleting a CIS cluster related NFV object, as illustrated in figure 6.4.5-1, consists of the following steps.

**Precondition:** The individual CIS cluster related NFV object of the respective type has been created.

- 1) The API consumer sends a DELETE request for the individual <CIS cluster related NFV object> identified by its name in the URI.
- 2) The CCM deletes the individual CIS cluster related NFV object.
- 3) The CCM returns a "200 OK" response to the API consumer and includes in the payload body a representation of the status details of the deletion operation.

**Postcondition:** Upon successful completion, the individual CIS cluster related NFV object has been deleted.

**Error handling:** In case of failure, appropriate error information is provided in the response.

## 6.5 Resources

### 6.5.1 Introduction

This clause profiles the resources and methods provided by the CCM service interface.

### 6.5.2 Resource: Cluster

This resource represents the Kubernetes® Cluster API custom resource object of a Cluster, which represents a Kubernetes® cluster with necessary configuration parameters. A Kubernetes® cluster is a grouping of Nodes. Kubernetes® could orchestrate containerized workload on these Nodes.

Table 6.5.2-1 provides the profiling of the supported Cluster resource methods against the CCM service interface requirements as specified in ETSI GS NFV-IFA 036 [1].

The URI query parameters, request and response bodies, and response codes of the individual resource methods are described in the respective Cluster custom resource object specifications of the profiled Kubernetes® Cluster API [2].

**Table 6.5.2-1: Cluster resource methods profiling against CCM service interface requirements**

Resource URI	HTTP Method	Meaning	Requirement identifier from ETSI GS NFV-IFA 036 [1]
/clusters	GET	List multiple Cluster instances. Request notifications in the event of changes to Cluster resource objects.	CcmCIMgt.002 CcmCIMgt.005
	POST	Create a new "Individual Cluster instance" resource.	CcmCIMgt.001
/clusters/{name}	GET	Get information about the desired and actual state of an "Individual Cluster instance" resource.	CcmCIMgt.002
	PATCH	Modify the desired or actual state of an "Individual Cluster instance" resource.	CcmCIMgt.003
	PUT	Replace an "Individual Cluster instance" resource.	CcmCIMgt.003
	DELETE	Delete an "Individual Cluster instance" resource.	CcmCIMgt.004

### 6.5.3 Resource: Machine

This resource represents the Kubernetes® Cluster API custom resource object of a Machine, which represents an infrastructure component hosting a Kubernetes® Node (for example, a Virtual Machine or a Bare-Metal server).

Table 6.5.3-1 provides the profiling of the supported Machine resource methods against the CCM service interface requirements as specified in ETSI GS NFV-IFA 036 [1].

The URI query parameters, request and response bodies, and response codes of the individual resource methods are described in the respective Machine custom resource object specifications of the profiled Kubernetes® Cluster API [2].

**Table 6.5.3-1: Machine resource methods profiling against CCM service interface requirements**

Resource URI	HTTP Method	Meaning	Requirement identifier from ETSI GS NFV-IFA 036 [1]
/machines	GET	List multiple Machine instances. Request notifications in the event of changes to Machine resource objects.	CcmCIMgt.002 CcmCIMgt.005
	POST	Create a new "Individual Machine instance" resource.	CcmCIMgt.001
/machines/{name}	GET	Get information about the desired and actual state of an "Individual Machine instance" resource.	CcmCIMgt.002
	PATCH	Modify the desired or actual state of an "Individual Machine instance" resource.	CcmCIMgt.003
	PUT	Replace an "Individual Machine instance" resource.	CcmCIMgt.003
	DELETE	Delete an "Individual Machine instance" resource.	CcmCIMgt.004

### 6.5.4 Resource: MachineDeployment

This resource represents the Kubernetes® Cluster API custom resource object of a MachineDeployment, which represents a set of Machines.

Table 6.5.4-1 provides the profiling of the supported MachineDeployment resource methods against the CCM service interface requirements as specified in ETSI GS NFV-IFA 036 [1].

The URI query parameters, request and response bodies, and response codes of the individual resource methods are described in the respective MachineDeployment custom resource object specifications of the profiled Kubernetes® Cluster API [2].

**Table 6.5.4-1: MachineDeployment resource methods profiling against CCM service interface requirements**

Resource URI	HTTP Method	Meaning	Requirement identifier from ETSI GS NFV-IFA 036 [1]
/machinedeployments	GET	List multiple MachineDeployment instances. Request notifications in the event of changes to MachineDeployment resource objects.	CcmCIMgt.002 CcmCIMgt.005
	POST	Create a new "Individual MachineDeployment instance" resource.	CcmCIMgt.001
/machinedeployments/{name}	GET	Get information about the desired and actual state of an "Individual MachineDeployment instance" resource.	CcmCIMgt.002
	PATCH	Modify the desired or actual state of an "Individual MachineDeployment instance" resource.	CcmCIMgt.003
	PUT	Replace an "Individual MachineDeployment instance" resource.	CcmCIMgt.003
	DELETE	Delete an "Individual MachineDeployment instance" resource.	CcmCIMgt.004

## 6.5.5 Resource: MachineSet

This resource represents the Kubernetes® Cluster API custom resource object of a MachineSet, which represents a stable set of Machines.

Table 6.5.5-1 provides the profiling of the supported MachineSet resource methods against the CCM service interface requirements as specified in ETSI GS NFV-IFA 036 [1].

The URI query parameters, request and response bodies, and response codes of the individual resource methods are described in the respective MachineSet custom resource object specifications of the profiled Kubernetes® Cluster API [2].

**Table 6.5.5-1: MachineSet resource methods profiling against CCM service interface requirements**

Resource URI	HTTP Method	Meaning	Requirement identifier from ETSI GS NFV-IFA 036 [1]
/machinesets	GET	List multiple MachineSet instances. Request notifications in the event of changes to MachineSet resource objects.	CcmCIMgt.002 CcmCIMgt.005
	POST	Create a new "Individual MachineSet instance" resource.	CcmCIMgt.001
/machinesets/{name}	GET	Get information about the desired and actual state of an "Individual MachineSet instance" resource.	CcmCIMgt.002
	PATCH	Modify the desired or actual state of an "Individual MachineSet instance" resource.	CcmCIMgt.003
	PUT	Replace an "Individual MachineSet instance" resource.	CcmCIMgt.003
	DELETE	Delete an "Individual MachineSet instance" resource.	CcmCIMgt.004

## 6.5.6 Resource: MachinePool

This resource represents the Kubernetes® Cluster API custom resource object of a MachinePool, which represents a set of Machines.

The MachinePool resource object provides a way to manage a set of Machines by defining a common configuration, number of desired machine replicas etc. similar to the MachineDeployment resource object, except that the MachineSet controllers are responsible for the lifecycle management of the Machines for a MachineDeployment, whereas in MachinePools, each infrastructure provider has a specific solution for orchestrating these Machines.

Table 6.5.6-1 provides the profiling of the supported MachinePool resource methods against the CCM service interface requirements as specified in ETSI GS NFV-IFA 036 [1].

The URI query parameters, request and response bodies, and response codes of the individual resource methods are described in the respective MachinePool custom resource object specifications of the profiled Kubernetes® Cluster API [2].

**Table 6.5.6-1: MachinePool resource methods profiling against CCM service interface requirements**

Resource URI	HTTP Method	Meaning	Requirement identifier from ETSI GS NFV-IFA 036 [1]
/machinepools	GET	List multiple MachinePool instances. Request notifications in the event of changes to MachinePool resource objects.	CcmCIMgt.002 CcmCIMgt.005
	POST	Create a new "Individual MachinePool instance" resource.	CcmCIMgt.001
/machinepools/{name}	GET	Get information about the desired and actual state of an "Individual MachinePool instance" resource.	CcmCIMgt.002
	PATCH	Modify the desired or actual state of an "Individual MachinePool instance" resource.	CcmCIMgt.003
	PUT	Replace an "Individual MachinePool instance" resource.	CcmCIMgt.003
	DELETE	Delete an "Individual MachinePool instance" resource.	CcmCIMgt.004

## 6.5.7 Resource: KubeadmControlPlane

This resource represents the Kubernetes® Cluster API custom resource object of a KubeadmControlPlane, which represents a set of components that serve the Kubernetes® API which is bootstrapped by Kubeadm.

Table 6.5.7-1 provides the profiling of the supported KubeadmControlPlane resource methods against the CCM service interface requirements as specified in ETSI GS NFV-IFA 036 [1].

The URI query parameters, request and response bodies, and response codes of the individual resource methods are described in the respective KubeadmControlPlane custom resource object specifications of the profiled Kubernetes® Cluster API [2].

**Table 6.5.7-1: KubeadmControlPlane resource methods profiling against CCM service interface requirements**

Resource URI	HTTP Method	Meaning	Requirement identifier from ETSI GS NFV-IFA 036 [1]
/kubeadmcontrolplanes	GET	List multiple KubeadmControlPlane instances. Request notifications in the event of changes to KubeadmControlPlane resource objects.	CcmCIMgt.002 CcmCIMgt.005
	POST	Create a new "Individual KubeadmControlPlane instance" resource.	CcmCIMgt.001
/kubeadmcontrolplanes/{name}	GET	Get information about the desired and actual state of an "Individual KubeadmControlPlane instance" resource.	CcmCIMgt.002
	PATCH	Modify the desired or actual state of an "Individual KubeadmControlPlane instance" resource.	CcmCIMgt.003
	PUT	Replace an "Individual KubeadmControlPlane instance" resource.	CcmCIMgt.003
	DELETE	Delete an "Individual KubeadmControlPlane instance" resource.	CcmCIMgt.004

## 6.6 Data model

The request and response data structures of the CIS cluster lifecycle management service interface are defined in the respective custom resource object specifications of the profiled Kubernetes® Cluster API [2].

---

# 7 CIS cluster configuration management service interface

## 7.1 Description

This interface allows the API consumer to invoke CIS cluster configuration management operations towards the API producer on:

- Transferring and applying CIS cluster configurations (see notes 1 and 2).
- Querying the information about CIS cluster configurations.

- Managing subscriptions to the notifications related to CIS cluster configuration management.
- Sending notifications in the event of CIS cluster configuration changes.

NOTE 1: Applying CIS cluster configurations encompasses the deletion and modification of configurations.

NOTE 2: The configuration information related to the CIS cluster can be either the configuration of the CIS cluster related object instances, e.g. CIS cluster node, CIS cluster storage, CIS cluster nodes network, CISM instance, CIS instance or a combination of the above.

## 7.2 API version

The API {VERSION} for the profiled Kubernetes® Cluster API [2] custom resource objects identified as CIS cluster related NFV objects shall be set to "v1beta1". Details on the API structure are specified in clause 4.3.2 of the present document.

The corresponding Kubernetes® Cluster API roots are specified as:

/apis/addons.cluster.x-k8s.io/v1beta1

/apis/bootstrap.cluster.x-k8s.io/v1beta1

## 7.3 Resource structure and methods

Figures 7.3-1, 7.3-2 and 7.3-3 show the overall resource URI structures for the profiled Kubernetes® Cluster API [2] for the CIS cluster configuration management service interface.

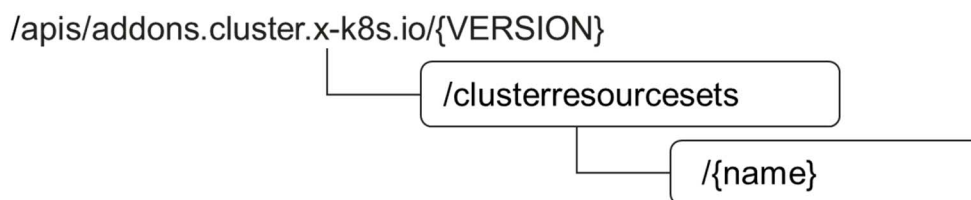

**Figure 7.3-1: Resource URI structure of ClusterResourceSet resource object for the CIS cluster configuration management service interface**

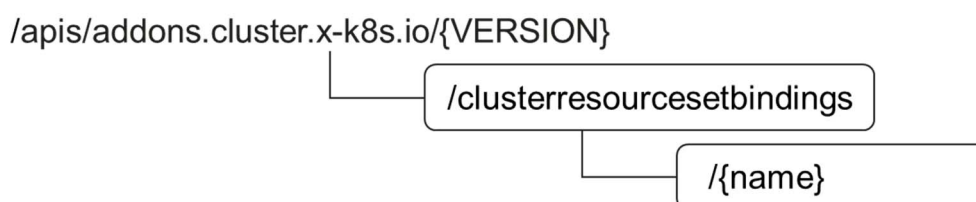

**Figure 7.3-2: Resource URI structure of ClusterResourceSetBinding resource object for the CIS cluster configuration management service interface**

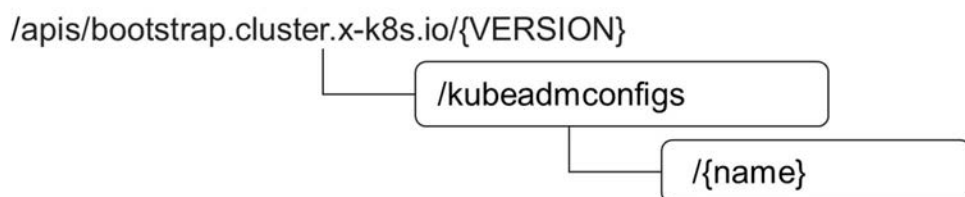

**Figure 7.3-3: Resource URI structure of KubeadmConfig resource object for the CIS cluster configuration management service interface**

Table 7.3-1 lists the individual resources defined, and the applicable HTTP methods.

The CCM supports responding to requests for all HTTP methods on the resources in Table 7.3-1 that are marked as "M" (mandatory) in the "Cat" column.

**Table 7.3-1: Resources and methods overview  
of the CIS cluster configuration management service interface**

Resource name	Resource URI	HTTP Method	Cat	Meaning
ClusterResourceSet	/clusterresourcesets	GET	M	List multiple ClusterResourceSet instances.
		POST	M	Create a new "Individual ClusterResourceSet instance" resource.
Individual ClusterResourceSet instance	/clusterresourcesets/{name}	GET	M	Get information about the desired and actual state of an "Individual ClusterResourceSet instance" resource.
		PATCH	M	Modify the desired or actual state of an "Individual ClusterResourceSet instance" resource.
		PUT	M	Replace an "Individual ClusterResourceSet instance" resource.
		DELETE	M	Delete an "Individual ClusterResourceSet instance" resource.
ClusterResourceSetBinding	/clusterresourcesetbindings	GET	M	List multiple ClusterResourceSetBinding instances.
		POST	M	Create a new "Individual ClusterResourceSetBinding instance" resource.
Individual ClusterResourceSetBinding instance	/clusterresourcesetbindings/{name}	GET	M	Get information about the desired and actual state of an "Individual ClusterResourceSetBinding instance" resource.
		PATCH	M	Modify the desired or actual state of an "Individual ClusterResourceSetBinding instance" resource.
		PUT	M	Replace an "Individual ClusterResourceSetBinding instance" resource.
		DELETE	M	Delete an "Individual ClusterResourceSetBinding instance" resource.
KubeadmConfig	/kubeadmconfigs	GET	M	List multiple KubeadmConfig instances.
		POST	M	Create a new "Individual KubeadmConfig instance" resource.
Individual KubeadmConfig instance	/kubeadmconfigs/{name}	GET	M	Get information about the desired and actual state of an "Individual KubeadmConfig instance" resource.
		PATCH	M	Modify the desired or actual state of an "Individual KubeadmConfig instance" resource.
		PUT	M	Replace an "Individual KubeadmConfig instance" resource.
		DELETE	M	Delete an "Individual KubeadmConfig instance" resource.



## 7.4 Sequence diagrams (informative)

The sequence diagrams provided in clause 6.4 are generalized so that they apply to all Kubernetes® Cluster API custom resource objects identified as CIS cluster related NFV objects. For CIS cluster configuration management service interface exposed via Cluster API custom resource objects and corresponding methods, in principle the same flows apply as depicted in the sequence diagrams of clause 6.4.

The diagrams and their description contain placeholders indicated as <CIS cluster related NFV objects> which need to be replaced by the applicable Cluster API custom resource name as listed in clause 7.3.

## 7.5 Resources

### 7.5.1 Introduction

This clause profiles the resources and methods provided by the CIS cluster configuration management service interface.

### 7.5.2 Resource: ClusterResourceSet

This resource represents the Kubernetes® Cluster API custom resource object of a ClusterResourceSet which contains the configuration data of a set of resources (such as CNI/CSI) to be applied to newly-created or existing clusters.

Table 7.5.2-1 provides the profiling of the supported ClusterResourceSet resource methods against the CIS cluster configuration management service interface requirements as specified in ETSI GS NFV-IFA 036 [1].

The URI query parameters, request and response bodies, and response codes of the individual resource methods are described in the respective ClusterResourceSet custom resource object specifications of the profiled Kubernetes® Cluster API [2].

**Table 7.5.2-1: ClusterResourceSet resource methods profiling against CIS cluster configuration management service interface requirements**

Resource URI	HTTP Method	Meaning	Requirement identifier from ETSI GS NFV-IFA 036 [1]
/clusterresourcesets	GET	List multiple ClusterResourceSet instances. Request notifications in the event of changes to ClusterResourceSet resource objects.	CcmCfgMgt.002 CcmCfgMgt.003 CcmCfgMgt.004
	POST	Create a new "Individual ClusterResourceSet instance" resource.	CcmCfgMgt.001
/clusterresourcesets/{name}	GET	Get information about the desired and actual state of an "Individual ClusterResourceSet instance" resource.	CcmCfgMgt.002
	PATCH	Modify the desired or actual state of an "Individual ClusterResourceSet instance" resource.	CcmCfgMgt.001
	PUT	Replace an "Individual ClusterResourceSet instance" resource.	CcmCfgMgt.001
	DELETE	Delete an "Individual ClusterResourceSet instance" resource.	CcmCfgMgt.001

### 7.5.3 Resource: ClusterResourceSetBinding

This resource represents the Kubernetes® Cluster API custom resource object of a ClusterResourceSetBinding which contains all matching ClusterResourceSets with the cluster it belongs to.

Table 7.5.3-1 provides the profiling of the supported ClusterResourceSetBinding resource methods against the CIS cluster configuration management service interface requirements as specified in ETSI GS NFV-IFA 036 [1].

The URI query parameters, request and response bodies, and response codes of the individual resource methods are described in the respective ClusterResourceSetBinding custom resource object specifications of the profiled Kubernetes® Cluster API [2].

**Table 7.5.3-1: ClusterResourceSetBinding resource methods profiling against CIS cluster configuration management service interface requirements**

Resource URI	HTTP Method	Meaning	Requirement identifier from ETSI GS NFV-IFA 036 [1]
/clusterresourcesetbindings	GET	List multiple ClusterResourceSetBinding instances. Request notifications in the event of changes to ClusterResourceSetBinding resource objects.	CcmCfgMgt.002 CcmCfgMgt.003 CcmCfgMgt.004
	POST	Create a new "Individual ClusterResourceSetBinding instance" resource.	CcmCfgMgt.001
/clusterresourcesetbindings/{name}	GET	Get information about the desired and actual state of an "Individual ClusterResourceSetBinding instance" resource.	CcmCfgMgt.002
	PATCH	Modify the desired or actual state of an "Individual ClusterResourceSetBinding instance" resource.	CcmCfgMgt.001
	PUT	Replace an "Individual ClusterResourceSetBinding instance" resource.	CcmCfgMgt.001
	DELETE	Delete an "Individual ClusterResourceSetBinding instance" resource.	CcmCfgMgt.001

## 7.5.4 Resource: KubeadmConfig

This resource represents the Kubernetes® Cluster API custom resource object of a KubeadmConfig which is used for generating a script to turn a Machine into a serviceable Kubernetes® node. In Cluster API, Kubeadm [i.8] is used to bootstrap the components that serve the Kubernetes® API in the default method [2].

Table 7.5.4-1 provides the profiling of the supported KubeadmConfig resource methods against the CIS cluster configuration management service interface requirements as specified in ETSI GS NFV-IFA 036 [1].

The URI query parameters, request and response bodies, and response codes of the individual resource methods are described in the respective KubeadmConfig custom resource object specifications of the profiled Kubernetes® Cluster API [2].

**Table 7.5.4-1: KubeadmConfig resource methods profiling against CIS cluster configuration management service interface requirements**

Resource URI	HTTP Method	Meaning	Requirement identifier from ETSI GS NFV-IFA 036 [1]
/kubeadmconfigs	GET	List multiple KubeadmConfig instances. Request notifications in the event of changes to KubeadmConfig resource objects.	CcmCfgMgt.002 CcmCfgMgt.003 CcmCfgMgt.004
	POST	Create a new "Individual KubeadmConfig instance" resource.	CcmCfgMgt.001

Resource URI	HTTP Method	Meaning	Requirement identifier from ETSI GS NFV-IFA 036 [1]
/kubeadmconfigs/{name}	GET	Get information about the desired and actual state of an "Individual KubeadmConfig instance" resource.	CcmCfgMgt.002
	PATCH	Modify the desired or actual state of an "Individual KubeadmConfig instance" resource.	CcmCfgMgt.001
	PUT	Replace an "Individual KubeadmConfig instance" resource.	CcmCfgMgt.001
	DELETE	Delete an "Individual KubeadmConfig instance" resource.	CcmCfgMgt.001

## 7.6 Data model

The request and response data structures of the CIS cluster configuration management service interface are defined in the respective custom resource object specifications of the profiled Kubernetes® Cluster API [2].

---

# 8 CIS cluster performance management service interface

Based on the analysis in clauses A.6 and A.7 of the present document, the majority CCM requirements could be met by profiling the open-source solution Kubernetes® Cluster API. The gap remaining is about the CIS cluster performance management and the granting operation consumed by CCM and produced by NFVO. For this version of the present document, the protocol and data model for CIS cluster performance management service interface is not specified.

---

# 9 CIS cluster fault management service interface

## 9.1 Description

This interface allows the API consumer to invoke CIS cluster fault management operations towards the API producer on:

- Collecting CIS cluster fault information (see note 1).
- Acknowledging of alarms.
- Managing subscriptions to the notifications related to alarms.
- Sending notifications in event of a creation, change or clearance of alarm information on a CIS cluster (see note 2).
- Sending notifications in event of rebuilt.

NOTE 1: Fault information on a given CIS cluster can include the information related to the alarm (e.g. alarm created, alarm cleared, etc.), alarm causes and identification of this CIS cluster and fault information concerning the infrastructure resources supporting the CIS cluster related object instances.

NOTE 2: Possible changes of alarm information include change state information, perceived severity, etc.

## 9.2 API version

The API {VERSION} for the profiled Kubernetes® Cluster API [2] custom resource objects identified as CIS cluster related NFV objects shall be set to "v1beta1". Details on the API structure are specified in clause 4.3.2 of the present document.

The corresponding Kubernetes® Cluster API roots are specified as:

```
/apis/cluster.x-k8s.io/v1beta1
```

## 9.3 Resource structure and methods

Figures 9.3-1, 9.3-2 and 9.3-3 show the overall resource URI structures for the profiled Kubernetes® Cluster API [2] for the CIS cluster fault management service interface.

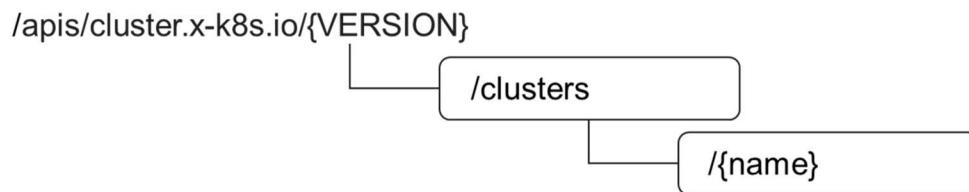

**Figure 9.3-1: Resource URI structure of Cluster resource object for the CIS cluster fault management service interface**

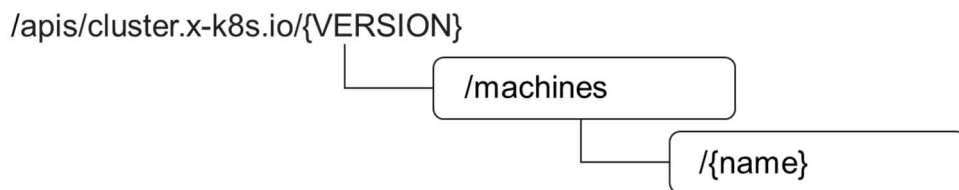

**Figure 9.3-2: Resource URI structure of Machine resource object for the CIS cluster fault management service interface**

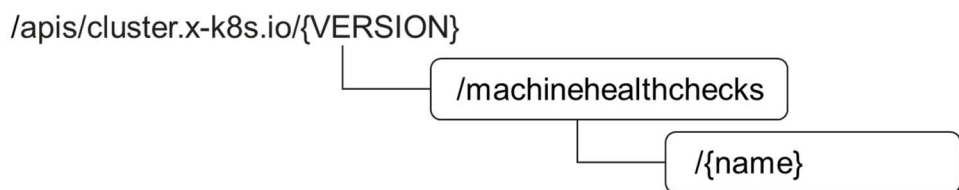

**Figure 9.3-3: Resource URI structure of MachineHealthCheck resource object for the CIS cluster fault management service interface**

Table 9.3-1 lists the individual resources defined, and the applicable HTTP methods.

The CCM supports responding to requests for all HTTP methods on the resources in Table 9.3-1 that are marked as "M" (mandatory) in the "Cat" column.

**Table 9.3-1: Resources and methods overview  
of the CIS cluster fault management service interface**

Resource name	Resource URI	HTTP Method	Cat	Meaning
Cluster	/clusters	GET	M	List multiple Cluster instances.
Individual Cluster instance	/clusters/{name}	GET	M	Get information about the desired and actual state of an "Individual Cluster instance" resource.
Machine	/machines	GET	M	List multiple Machine instances.
Individual Machine instance	/machines/{name}	GET	M	Get information about the desired and actual state of an "Individual Machine instance" resource.
MachineHealthCheck	/machinehealthchecks	GET	M	List multiple MachineHealthCheck instances.
		POST	M	Create a new "Individual MachineHealthCheck instance" resource.
Individual MachineHealthCheck instance	/machinehealthchecks/{name}	GET	M	Get information about the desired and actual state of an "Individual MachineHealthCheck instance" resource.
		PATCH	M	Modify the desired or actual state of an "Individual MachineHealthCheck instance" resource.
		PUT	M	Replace an "Individual MachineHealthCheck instance" resource.
		DELETE	M	Delete an "Individual MachineHealthCheck instance" resource.

## 9.4 Sequence diagrams (informative)

The sequence diagrams provided in clause 6.4 are generalized so that they apply to all Kubernetes® Cluster API custom resource objects identified as CIS cluster related NFV objects. For CIS cluster fault management service interface exposed via Cluster API custom resource objects and corresponding methods, in principle the same flows apply as depicted in the sequence diagrams of clause 6.4.

The diagrams and their description contain placeholders indicated as <CIS cluster related NFV objects> which need to be replaced by the applicable Cluster API custom resource name as listed in clause 9.3.

## 9.5 Resources

### 9.5.1 Introduction

This clause profiles the resources and methods provided by the CIS cluster fault management service interface.

### 9.5.2 Resource: Cluster

This resource represents the Kubernetes® Cluster API custom resource object of a Cluster, which represents a Kubernetes® cluster. For the fault management of a CIS cluster, Cluster resource status contains the descriptive fault message and failure reason information.

Table 9.5.2-1 provides the profiling of the supported Cluster resource methods against the CIS cluster fault management service interface requirements as specified in ETSI GS NFV-IFA 036 [1].

The URI query parameters, request and response bodies, and response codes of the individual resource methods are described in the respective Cluster custom resource object specifications of the profiled Kubernetes® Cluster API [2].

**Table 9.5.2-1: Cluster resource methods profiling against CIS cluster fault management service interface requirements**

Resource URI	HTTP Method	Meaning	Requirement identifier from ETSI GS NFV-IFA 036 [1]
/clusters	GET	List multiple Cluster instances. Request notifications in the event of changes (including changes in fault information) to Cluster resource objects.	CcmFltMgt.001 CcmFltMgt.002 CcmFltMgt.003 CcmFltMgt.004 CcmFltMgt.006 CcmFltMgt.007
/clusters/{name}	GET	Get information about the desired and actual state of an "Individual Cluster instance" resource. Request notifications in the event of changes (including changes in fault information) to an "Individual Cluster instance" resource.	CcmFltMgt.001 CcmFltMgt.002 CcmFltMgt.003 CcmFltMgt.004 CcmFltMgt.006 CcmFltMgt.007

### 9.5.3 Resource: Machine

This resource represents the Kubernetes® Cluster API custom resource object of a Machine, which represents an infrastructure component hosting a node. For the fault management of CIS cluster node(s), Machine resource status contains the descriptive fault message and failure reason information.

Table 9.5.3-1 provides the profiling of the supported Machine resource methods against the CIS cluster fault management service interface requirements as specified in ETSI GS NFV-IFA 036 [1].

The URI query parameters, request and response bodies, and response codes of the individual resource methods are described in the respective Machine custom resource object specifications of the profiled Kubernetes® Cluster API [2].

**Table 9.5.3-1: Machine resource methods profiling against CIS cluster fault management service interface requirements**

Resource URI	HTTP Method	Meaning	Requirement identifier from ETSI GS NFV-IFA 036 [1]
/machines	GET	List multiple Machine instances. Request notifications in the event of changes (including changes in fault information) to Machine resource objects.	CcmFltMgt.001 CcmFltMgt.002 CcmFltMgt.003 CcmFltMgt.004 CcmFltMgt.006 CcmFltMgt.007
/machines/{name}	GET	Get information about the desired and actual state of an "Individual Machine instance" resource. Request notifications in the event of changes (including changes in fault information) to an "Individual Machine instance" resource.	CcmFltMgt.001 CcmFltMgt.002 CcmFltMgt.003 CcmFltMgt.004 CcmFltMgt.006 CcmFltMgt.007

## 9.5.4 Resource: MachineHealthCheck

This resource represents the Kubernetes® Cluster API custom resource object of a MachineHealthCheck, which is responsible for checking the health of Machines in the Clusters against a list of unhealthy conditions and remediating unhealthy Machines.

Table 9.5.4-1 provides the profiling of the supported MachineHealthCheck resource methods against the CIS cluster fault management service interface requirements as specified in ETSI GS NFV-IFA 036 [1].

The URI query parameters, request and response bodies, and response codes of the individual resource methods are described in the respective MachineHealthCheck custom resource object specifications of the profiled Kubernetes® Cluster API [2].

**Table 9.5.4-1: MachineHealthCheck resource methods profiling against CIS cluster fault management service interface requirements**

Resource URI	HTTP Method	Meaning	Requirement identifier from ETSI GS NFV-IFA 036 [1]
/machinehealthchecks	GET	List multiple MachineHealthCheck instances. Request notifications in the event of changes to MachineHealthCheck resource objects.	CcmFitMgt.001 CcmFitMgt.002 CcmFitMgt.003 CcmFitMgt.004 CcmFitMgt.006 CcmFitMgt.007
	POST	Create a new "Individual MachineHealthCheck instance" resource.	CcmFitMgt.001 CcmFitMgt.005
/machinehealthchecks/{name}	GET	Get information about the desired and actual state of an "Individual MachineHealthCheck instance" resource. Request notifications in the event of changes to an "Individual MachineHealthCheck instance" resource.	CcmFitMgt.001 CcmFitMgt.002 CcmFitMgt.003 CcmFitMgt.004 CcmFitMgt.006 CcmFitMgt.007
	PATCH	Modify the desired or actual state of an "Individual MachineHealthCheck instance" resource.	CcmFitMgt.001 CcmFitMgt.005
	PUT	Replace an "Individual MachineHealthCheck instance" resource.	CcmFitMgt.001 CcmFitMgt.005
	DELETE	Delete an "Individual MachineHealthCheck instance" resource.	CcmFitMgt.001 CcmFitMgt.005

## 9.6 Data model

The request and response data structures of the CIS cluster fault management service interface are defined in the respective custom resource object specifications of the profiled Kubernetes® Cluster API [2].

## 10 CIS cluster security management service interface

### 10.1 Description

This interface allows the API consumer to invoke CIS cluster security management operations towards the API producer on:

- Configuration of security related information and artifacts for CIS cluster (see note).
- Configuration of authorization and authentication for invoking CISM capabilities (see note).
- Configuration of auditing related information for CIS cluster.

NOTE: The security information for the configuration is provided by entities responsible for security management [1].

### 10.2 Features profiling

The Cluster API, as a sub-project of the Kubernetes® API, provides additional features which are not exposed via resource objects and corresponding methods. Instead, they are provided as functional capabilities.

Table 10.2-1 provides the profiling of the Kubernetes® API additional features against the CIS cluster security management service interface requirements as specified in ETSI GS NFV-IFA 036 [1].

**Table 10.2-1: Kubernetes® API features profiling against CIS cluster security management service interface requirements**

API feature	Description	Requirement identifier from ETSI GS NFV-IFA 036 [1]
Kubernetes® API Access Control [5]	Users and Kubernetes® service accounts can be authenticated and authorized for API access.	CcmSecMgt.001 CcmSecMgt.002
Kubernetes® Auditing [6]	Kubernetes® auditing provides a security-relevant, chronological set of records documenting the sequence of actions in a CIS cluster.	CcmSecMgt.001 CcmSecMgt.003

Data structures related to the features profiling against CIS cluster security management service interface requirements are defined in the respective specifications of the Kubernetes® API [3], which is the parent project of the profiled solution Cluster API.



## Annex A (informative): Analysis on the open-source solutions based on the CCM service interface requirements

### A.1 Kubernetes® Cluster API

#### A.1.1 Overview

This clause analyses comparison of CCM requirements (including CCM service interface requirements specified in ETSI GS NFV-IFA 036 [1] and CCM functional requirements specified in ETSI GS NFV-IFA 010 [i.4]), and Kubernetes® Cluster API (Cluster API, or CAPI in abbreviation).

Kubernetes® Cluster API is a Kubernetes® sub-project focused on providing declarative APIs and tooling to simplify provisioning, upgrading, and operating multiple Kubernetes® clusters. CAPI uses Kubernetes® Custom Resource Definitions (CRDs) to represent the cluster related resources as native Kubernetes® objects.

#### A.1.2 Comparison of CCM service interface requirements and Kubernetes® Cluster API capabilities

This clause shows comparison of CCM service interface requirements defined in clause 5.1 of ETSI GS NFV-IFA 036 [1] as "Identifier" column and "Requirement" column from Table A.1.2-1 to Table A.1.2-6 and Kubernetes® Cluster API as "Support by open source" and "Related capability of open source" column. The legend of "Support by open source" are following:

- "Yes": fully support the CCM service requirements.
- "No": not support the CCM service requirements.
- "Partial": partial support the CCM service requirements.

**Table A.1.2-1: Comparison of CCM service requirements and Kubernetes® Cluster API**

Identifier	Requirement	Support by open source	Related capability of open source
CcmSvc.001	The CCM shall provide a CIS cluster lifecycle management service.	Yes	Using K8s® style API regarding Cluster as custom resource
CcmSvc.002	The CCM shall provide a CIS cluster fault management service.	Yes	Using K8s® style API regarding MachineHealthCheck as custom resource
CcmSvc.003	The CCM shall provide a CIS cluster configuration management service.	Yes	Using K8s® style API regarding Cluster as custom resource
CcmSvc.004	The CCM shall provide a CIS cluster performance management service.	Partial	More details in "Related capability of open source" column in Table A.1.2-5
CcmSvc.005	The CCM shall provide a CIS cluster security management service.	Yes	Using K8s® mechanism for security assurance
CcmSvc.006	The services provided by the CCM shall support access control (e.g. RBAC).	Yes	Using K8s® mechanism for access control

**Table A.1.2-2: Comparison of CIS cluster lifecycle management service interface requirements and Kubernetes® Cluster API**

Identifier	Requirement	Support by open source	Related capability of open source
CcmCIMgt.001	The CIS cluster lifecycle management service interface produced by the CCM shall support creating a CIS cluster.	Yes	Using K8s® style API for CAPI resource object Cluster
CcmCIMgt.002	The CIS cluster lifecycle management service interface produced by the CCM shall support querying information about a CIS cluster.	Yes	
CcmCIMgt.003	The CIS cluster lifecycle management service interface produced by the CCM shall support modifying a CIS cluster.	Yes	
CcmCIMgt.004	The CIS cluster lifecycle management service interface produced by the CCM shall support deleting a CIS cluster.	Yes	
CcmCIMgt.005	The CIS cluster lifecycle management service interface produced by the CCM shall support sending notifications in the event of changes to a CIS cluster.	Yes	

**Table A.1.2-3: Comparison of CIS cluster fault management service interface requirements and Kubernetes® Cluster API**

Identifier	Requirement	Support by open source	Related capability of open source
CcmFitMgt.001	The CIS cluster fault management service interface produced by the CCM shall enable its Consumers to collect CIS cluster fault information.	Yes	Using K8s® style API regarding MachineHealthCheck as custom resource object. Nodes for CIS instances and CISM instances are collected respectively
CcmFitMgt.002	The CIS cluster fault management service interface produced by the CCM shall support sending notifications in event of a change in alarm information on a CIS cluster.	Yes	
CcmFitMgt.003	The CIS cluster fault management service interface produced by the CCM shall support sending notifications in event of the creation of an alarm on a CIS cluster.	Yes	
CcmFitMgt.004	The CIS cluster fault management service interface produced by the CCM shall support sending notifications in event of the clearance of an alarm on CIS cluster.	Yes	
CcmFitMgt.005	The CIS cluster fault management service interface produced by the CCM shall support acknowledgement of an alarm.	Yes	
CcmFitMgt.006	The CIS cluster fault management service interface produced by the CCM shall support sending notifications in event of rebuilt.	Yes	
CcmFitMgt.007	The CIS cluster fault management service interface produced by the CCM shall support managing subscriptions to the notifications related to alarms.	Yes	

**Table A.1.2-4: Comparison of CIS cluster configuration management service interface requirements and Kubernetes® Cluster API**

Identifier	Requirement	Support by open source	Related capability of open source
CcmCfgMgt.001	The CIS cluster configuration management service interface produced by the CCM shall support transferring and applying CIS cluster configurations provided by the CCM Consumer.	Yes	Using K8s® style API for CAPI resource object Cluster
CcmCfgMgt.002	The CIS cluster configuration management service interface produced by the CCM shall support querying the information about CIS cluster configurations.	Yes	
CcmCfgMgt.003	The CIS cluster configuration management service interface produced by the CCM shall support sending notifications in the event of CIS cluster configuration changes.	Yes	
CcmCfgMgt.004	The CIS cluster configuration management service interface produced by the CCM shall support managing subscriptions to the notifications related to configuration management.	Yes	

**Table A.1.2-5: Comparison of CIS cluster performance management service interface requirements and Kubernetes® Cluster API**

Identifier	Requirement	Support by open source	Related capability of open source
CcmPerfMgt.001	The CIS cluster performance management service interface produced by the CCM shall support controlling the collection and reporting of CIS cluster performance information, resulting from infrastructure resources (VMs or bare-metal servers) performance information, on the CIS cluster(s) it manages.	Partial	As a K8s® add-on, CAPI support these requirements by by invoking CISM(K8s® API) capabilities.  Basic performance/ capacity monitoring and management for each CIS node is done by K8s® (CISM) with Kubelet on that Node object  (e.g. Including CPU/MEMORY/DISK PRESSURE monitoring, notification and management for each K8s® node)  See
CcmPerfMgt.002	The CIS cluster performance management service interface produced by the CCM shall support sending notifications in the event of the availability of CIS cluster performance information.	Partial	
CcmPerfMgt.003	The CIS cluster performance management service interface produced by the CCM shall support creating a PM job specifying the CIS cluster performance information to be collected.	Partial	
CcmPerfMgt.004	The CIS cluster performance management service interface produced by the CCM shall support deleting one or more PM job(s).	Partial	
CcmPerfMgt.005	The CIS cluster performance management service interface produced by the CCM shall support querying the information about one or more PM job(s).	Partial	
CcmPerfMgt.006	The CIS cluster performance management service interface produced by the CCM shall support managing the thresholds on specified CIS cluster performance information.	Partial	
CcmPerfMgt.007	The CIS cluster performance management service interface produced by the CCM shall support sending notifications in the event of a threshold defined for a specified metric of a CIS cluster being crossed.	Partial	
CcmPerfMgt.008	The CIS cluster performance management service interface produced by the CCM shall support managing subscriptions to the notifications related to performance management.	Partial	

Identifier	Requirement	Support by open source	Related capability of open source
CcmPerfMgt.009	The CIS cluster performance management service interface produced by the CCM shall support sending notifications in the event of shortage of capacity in the CIS cluster.	Partial	<a href="https://kubernetes.io/docs/concepts/architecture/nodes/#node-status">https://kubernetes.io/docs/concepts/architecture/nodes/#node-status</a>

**Table A.1.2-6: Comparison of CIS cluster security management service interface requirements and Kubernetes® Cluster API**

Identifier	Requirement	Support by open source	Related capability of open source
CcmSecMgt.001	The CIS cluster security management service interface produced by the CCM shall support configuration of security related information and artifacts for secure communication among CIS cluster nodes.	Yes	Using K8s® mechanism for security assurance
CcmSecMgt.002	The CIS cluster security management service interface produced by the CCM shall support configuration of authorization and authenticate invoking CISM capabilities from external and/or internal entities of the CIS cluster by using configuration files and declarative descriptors representing RBAC.	Yes	Using K8s® mechanism for access control
CcmSecMgt.003	The CIS cluster security management service interface produced by the CCM shall support configuration of auditing related information for auditing of CIS cluster nodes.	Yes	Using K8s® mechanism for auditing

### A.1.3 Comparison of CCM functional requirements and Kubernetes® Cluster API capabilities

This clause shows comparison of CCM functional requirements defined in clause 5.1 of ETSI GS NFV-IFA 010 [i.4] as "Numbering" column and "Functional requirements description" column from Table A.1.3-1 to Table A.1.3-5 and Kubernetes® Cluster API as "Support by open source" column. The legend of "Support by open source" are following:

- "Yes": fully support the CCM service requirements.
- "No": not support the CCM service requirements.
- "Partial": partial support the CCM service requirements.

**Table A.1.3-1: Comparison of CIS cluster resource management functional requirements and Kubernetes® Cluster API**

Numbering	Functional requirements description	Support by open source
Ccm.Ciscrm.001	In the case of VM-based CIS cluster, the CCM function shall support the capability to request compute, storage and network virtualised resource management from the VIM that fulfils the specified compute/storage/network resource requests and placement constraints for a CIS cluster.	Yes
Ccm.Ciscrm.002	In the case of bare-metal CIS cluster, the CCM function shall support the capability to request compute, storage and network resources management from corresponding physical resources infrastructure management that fulfils the specified compute/storage/network resource requests and placement constraints for a CIS cluster.	Yes

Numbering	Functional requirements description	Support by open source
Ccm.Ciscrm.003	In the case of a CIS cluster to be deployed as one or more VNF, the CCM function shall support the capability to request NS lifecycle management from the NFVO that fulfils the specified VNF and NS requests and placement constraints for a CIS cluster.	No
Ccm.Ciscrm.004	The CCM function shall support the capability to manage the installation of network-related artefacts (e.g. executables or plugins) into the CIS cluster nodes to enable container cluster networking, i.e. primary and secondary container cluster networks.	Yes
Ccm.Ciscrm.005	The CCM function shall support the capability to process the information about resource requirements from the CIS cluster descriptor for performing the necessary resource management for the CIS cluster.	Yes
Ccm.Ciscrm.006	The CCM function shall support the capability to request an operation granting before executing the CIS cluster lifecycle operation procedure and whenever changes in usage of necessary physical and/or virtualised compute, storage and network resources is expected.	No, but this service is consumed by CCM, not produced by CCM

**Table A.1.3-2: Comparison of CIS cluster configuration management functional requirements and Kubernetes® Cluster API**

Numbering	Functional requirements description	Support by open source
Ccm.Ciscfgm.001	The CCM function shall support the capability to configure the CIS cluster control plane endpoints with necessary IP and name resolution information.	Yes
Ccm.Ciscfgm.002	The CCM function shall support the capability to retrieve cluster-nodes network-related information about the CIS cluster nodes and configure the CIS cluster nodes with cluster nodes network-related configuration.	Yes
Ccm.Ciscfgm.003	The CCM function shall support the capability to request the CISM to apply corresponding network configuration for the primary container cluster network and secondary container cluster networks.	Yes
Ccm.Ciscfgm.004	The CCM function shall support the capability to configure the CISM with appropriate infrastructure provider controller information to enable the CISM to request the creation and setup of necessary network resources (e.g. external load balancer).	Yes
Ccm.Ciscfgm.005	The CCM function shall support the capability to configure the CISM with necessary configuration about access control.	Yes
Ccm.Ciscfgm.006	The CCM function shall support the capability to configure the CISM with provisioned storage resources for the CIS cluster.	Yes

**Table A.1.3-3: Comparison of CIS cluster descriptor management functional requirements and Kubernetes® Cluster API**

Numbering	Functional requirements description	Support by open source
Ccm.Ccdm.001	The CCM function shall support the capability of management of CIS cluster descriptors.	Yes
Ccm.Ccdm.002	The CCM function shall support the capability to verify the integrity and authenticity of the CIS cluster descriptor.	No
Ccm.Ccdm.003	The CCM function shall support the capability to verify that all mandatory information in the CIS cluster descriptor is present and complies with the standard for this information.	No
Ccm.Ccdm.004	The CCM function shall support the capability to notify about the result of management operations and changes of CIS cluster descriptors.	Yes

**Table A.1.3-4: Comparison of CIS cluster fault, performance and capacity management functional requirements and Kubernetes® Cluster API**

Numbering	Functional requirements description	Support by open source
Ccm.Cisassu.001	The CCM function shall support the capability to monitor the resources capacity in the CIS cluster and issue notifications related to capacity events and information.	Partial, more details in "Related capability of open source" column in Table A.1.2-5
Ccm.Cisassu.002	The CCM function shall support the capability to monitor for faults in the CIS cluster, and issue notifications and provide information related to alarms and fault events.	Yes
Ccm.Cisassu.003	The CCM function shall support the capability to monitor the performance of the CIS cluster, and issue notifications and provide information related to performance.	Partial, more details in "Related capability of open source" column in Table A.1.2-5
Ccm.Cisassu.004	The CCM function shall support the capability for a consumer to subscribe to notifications related to capacity, performance and fault events.	Yes

**Table A.1.3-5: comparison of CIS cluster lifecycle management functional requirements and Kubernetes® Cluster API**

Numbering	Functional requirements description	Support by open source
Ccm.Cislcm.001	The CCM function shall support the capability to create a CIS cluster.	Yes
Ccm.Cislcm.002	The CCM function shall support the capability to provide information about a CIS cluster and its CIS cluster nodes.	Yes
Ccm.Cislcm.003	The CCM function shall support the capability to modify a CIS cluster.	Yes
Ccm.Cislcm.004	The CCM function shall support the capability to delete a CIS cluster.	Yes
Ccm.Cislcm.005	The CCM function shall support the capability to notify on events related to changes to a CIS cluster and its CIS cluster nodes.	Yes

**Table A.1.3-6: comparison of CIS MCCO management requirements and Kubernetes® Cluster API**

Numbering	Functional requirements description	Support by open source
Ccm.Mccom.001	The CCM function shall support the capability to install (apply) an MCCO to the CIS cluster.	Yes
Ccm.Mccom.002	The CCM function shall support the capability to delete an MCCO from the CIS cluster.	Yes
Ccm.Mccom.003	The CCM function shall support the capability to modify an MCCO installed (applied) in a CIS cluster.	Yes
Ccm.Mccom.004	The CCM function shall support the capability to inventory the MCCOs installed (applied) in a CIS cluster.	Yes
Ccm.Mccom.005	The CCM function shall support the capability to provide information about the MCCOs that have been inventoried.	Yes
Ccm.Mccom.006	The CCM function shall support the capability to process the information about resource requirements from the MCCO declarative descriptor for performing the necessary resources management for the MCCO.	Yes

## A.2 Terraform

### A.2.1 Overview

This clause analyses comparison of CCM requirements (including CCM service interface requirements specified in ETSI GS NFV-IFA 036 [1] and CCM functional requirements specified in ETSI GS NFV-IFA 010 [i.4]), and open source solution Terraform.

Terraform is an open source tool for realizing "infrastructure as a code" to config and manage diversified infrastructure. Terraform aims to enable user to create and change the infrastructure using a declarative configuration format known as HashiCorp® Configuration Language (HCL).

## A.2.2 Comparison of CCM service interface requirements and Terraform capabilities

This clause shows comparison of CCM service interface requirements defined in clause 5.1 of ETSI GS NFV-IFA 036 [1] as "Identifier" column and "Requirement" column from Table A.2.2-1 to Table A.2.2-6 and Terraform as "Support by open source" and "Related capability of open source" column. The legend of "Support by open source" are following:

- "Yes": fully support the CCM service requirements.
- "No": not support the CCM service requirements.
- "Partial": partial support the CCM service requirements.

**Table A.2.2-1: Comparison of CCM service requirements and Terraform**

Identifier	Requirement	Support by open source	Related capability of open source
CcmSvc.001	The CCM shall provide a CIS cluster lifecycle management service.	Yes	Execute with related Terraform manifest
CcmSvc.002	The CCM shall provide a CIS cluster fault management service.	No	
CcmSvc.003	The CCM shall provide a CIS cluster configuration management service.	Yes	Execute with related Terraform manifest
CcmSvc.004	The CCM shall provide a CIS cluster performance management service.	No	
CcmSvc.005	The CCM shall provide a CIS cluster security management service.	Yes	Execute with related Terraform manifest
CcmSvc.006	The services provided by the CCM shall support access control (e.g. RBAC).	Yes	Execute with related Terraform manifest

**Table A.2.2-2: Comparison of CIS cluster lifecycle management service interface requirements and Terraform**

Identifier	Requirement	Support by open source	Related capability of open source
CcmCIMgt.001	The CIS cluster lifecycle management service interface produced by the CCM shall support creating a CIS cluster.	Yes	Execute with related Terraform manifest
CcmCIMgt.002	The CIS cluster lifecycle management service interface produced by the CCM shall support querying information about a CIS cluster.	Yes	Execute with related Terraform manifest
CcmCIMgt.003	The CIS cluster lifecycle management service interface produced by the CCM shall support modifying a CIS cluster.	Yes	Execute with related Terraform manifest
CcmCIMgt.004	The CIS cluster lifecycle management service interface produced by the CCM shall support deleting a CIS cluster.	Yes	Execute with related Terraform manifest
CcmCIMgt.005	The CIS cluster lifecycle management service interface produced by the CCM shall support sending notifications in the event of changes to a CIS cluster.	No	Terraform do not have APIs but CLIs and, it calls provider APIs when invoked.

**Table A.2.2-3: Comparison of CIS cluster fault management service interface requirements and Terraform**

Identifier	Requirement	Support by open source	Related capability of open source
CcmFitMgt.001	The CIS cluster fault management service interface produced by the CCM shall enable its Consumers to collect CIS cluster fault information.	No	
CcmFitMgt.002	The CIS cluster fault management service interface produced by the CCM shall support sending notifications in event of a change in alarm information on a CIS cluster.	No	
CcmFitMgt.003	The CIS cluster fault management service interface produced by the CCM shall support sending notifications in event of the creation of an alarm on a CIS cluster.	No	
CcmFitMgt.004	The CIS cluster fault management service interface produced by the CCM shall support sending notifications in event of the clearance of an alarm on CIS cluster.	No	
CcmFitMgt.005	The CIS cluster fault management service interface produced by the CCM shall support acknowledgement of an alarm.	No	
CcmFitMgt.006	The CIS cluster fault management service interface produced by the CCM shall support sending notifications in event of rebuilt.	No	
CcmFitMgt.007	The CIS cluster fault management service interface produced by the CCM shall support managing subscriptions to the notifications related to alarms.	No	

**Table A.2.2-4: Comparison of CIS cluster configuration management service interface requirements and Terraform**

Identifier	Requirement	Support by open source	Related capability of open source
CcmCfgMgt.001	The CIS cluster configuration management service interface produced by the CCM shall support transferring and applying CIS cluster configurations provided by the CCM Consumer.	Yes	Execute with related Terraform manifest
CcmCfgMgt.002	The CIS cluster configuration management service interface produced by the CCM shall support querying the information about CIS cluster configurations.	Yes	Execute with related Terraform manifest
CcmCfgMgt.003	The CIS cluster configuration management service interface produced by the CCM shall support sending notifications in the event of CIS cluster configuration changes.	No	
CcmCfgMgt.004	The CIS cluster configuration management service interface produced by the CCM shall support managing subscriptions to the notifications related to configuration management.	No	



**Table A.2.2-5: Comparison of CIS cluster performance management service interface requirements and Terraform**

Identifier	Requirement	Support by open source	Related capability of open source
CcmPerfMgt.001	The CIS cluster performance management service interface produced by the CCM shall support controlling the collection and reporting of CIS cluster performance information, resulting from infrastructure resources (VMs or bare-metal servers) performance information, on the CIS cluster(s) it manages.	No	
CcmPerfMgt.002	The CIS cluster performance management service interface produced by the CCM shall support sending notifications in the event of the availability of CIS cluster performance information.	No	
CcmPerfMgt.003	The CIS cluster performance management service interface produced by the CCM shall support creating a PM job specifying the CIS cluster performance information to be collected.	No	
CcmPerfMgt.004	The CIS cluster performance management service interface produced by the CCM shall support deleting one or more PM job(s).	No	
CcmPerfMgt.005	The CIS cluster performance management service interface produced by the CCM shall support querying the information about one or more PM job(s).	No	
CcmPerfMgt.006	The CIS cluster performance management service interface produced by the CCM shall support managing the thresholds on specified CIS cluster performance information.	No	
CcmPerfMgt.007	The CIS cluster performance management service interface produced by the CCM shall support sending notifications in the event of a threshold defined for a specified metric of a CIS cluster being crossed.	No	
CcmPerfMgt.008	The CIS cluster performance management service interface produced by the CCM shall support managing subscriptions to the notifications related to performance management.	No	
CcmPerfMgt.009	The CIS cluster performance management service interface produced by the CCM shall support sending notifications in the event of shortage of capacity in the CIS cluster.	No	-

**Table A.2.2-6: Comparison of CIS cluster security management service interface requirements and Terraform**

Identifier	Requirement	Support by open source	Related capability of open source
CcmSecMgt.001	The CIS cluster security management service interface produced by the CCM shall support configuration of security related information and artifacts for secure communication among CIS cluster nodes.	Yes	Execute with related Terraform manifest
CcmSecMgt.002	The CIS cluster security management service interface produced by the CCM shall support configuration of authorization and authenticate invoking CISM capabilities from external and/or internal entities of the CIS cluster by using configuration files and declarative descriptors representing RBAC.	Yes	Execute with related Terraform manifest
CcmSecMgt.003	The CIS cluster security management service interface produced by the CCM shall support configuration of auditing related information for auditing of CIS cluster nodes.	Yes	Execute with related Terraform manifest

## A.2.3 Comparison of CCM functional requirements and Terraform capabilities

This clause shows comparison of CCM functional requirements defined in clause 5.1 of ETSI GS NFV-IFA 010 [i.4] as "Numbering" column and "Functional requirements description" column from Table A.2.3-1 to Table A.2.3-5 and Terraform as "Support by open source" column. The legend of "Support by open source" are following:

- "Yes": fully support the CCM service requirements.
- "No": not support the CCM service requirements.
- "Partial": partial support the CCM service requirements.

**Table A.2.3-1: Comparison of CIS cluster resource management functional requirements and Terraform**

Numbering	Functional requirements description	Support by open source
Ccm.Ciscrm.001	In the case of VM-based CIS cluster, the CCM function shall support the capability to request compute, storage and network virtualised resource management from the VIM that fulfils the specified compute/storage/network resource requests and placement constraints for a CIS cluster.	Yes
Ccm.Ciscrm.002	In the case of bare-metal CIS cluster, the CCM function shall support the capability to request compute, storage and network resources management from corresponding physical resources infrastructure management that fulfils the specified compute/storage/network resource requests and placement constraints for a CIS cluster.	Partial, depends on underlying provider
Ccm.Ciscrm.003	In the case of a CIS cluster to be deployed as one or more VNF, the CCM function shall support the capability to request NS lifecycle management from the NFVO that fulfils the specified VNF and NS requests and placement constraints for a CIS cluster.	No
Ccm.Ciscrm.004	The CCM function shall support the capability to manage the installation of network-related artefacts (e.g. executables or plugins) into the CIS cluster nodes to enable container cluster networking, i.e. primary and secondary container cluster networks.	Yes
Ccm.Ciscrm.005	The CCM function shall support the capability to process the information about resource requirements from the CIS cluster descriptor for performing the necessary resource management for the CIS cluster.	No
Ccm.Ciscrm.006	The CCM function shall support the capability to request an operation granting before executing the CIS cluster lifecycle operation procedure and whenever changes in usage of necessary physical and/or virtualised compute, storage and network resources is expected.	No, but this service is consumed by CCM, not produced by CCM

**Table A.2.3-2: Comparison of CIS cluster configuration management functional requirements and Terraform**

Numbering	Functional requirements description	Support by open source
Ccm.Ciscfgm.001	The CCM function shall support the capability to configure the CIS cluster control plane endpoints with necessary IP and name resolution information.	Yes
Ccm.Ciscfgm.002	The CCM function shall support the capability to retrieve cluster-nodes network-related information about the CIS cluster nodes and configure the CIS cluster nodes with cluster nodes network-related configuration.	Yes
Ccm.Ciscfgm.003	The CCM function shall support the capability to request the CISM to apply corresponding network configuration for the primary container cluster network and secondary container cluster networks.	Yes
Ccm.Ciscfgm.004	The CCM function shall support the capability to configure the CISM with appropriate infrastructure provider controller information to enable the CISM to request the creation and setup of necessary network resources (e.g. external load balancer).	Yes
Ccm.Ciscfgm.005	The CCM function shall support the capability to configure the CISM with necessary configuration about access control.	Yes
Ccm.Ciscfgm.006	The CCM function shall support the capability to configure the CISM with provisioned storage resources for the CIS cluster.	Yes

**Table A.2.3-3: Comparison of CIS cluster descriptor management functional requirements and Terraform**

Numbering	Functional requirements description	Support by open source
Ccm.Ccdm.001	The CCM function shall support the capability of management of CIS cluster descriptors.	No
Ccm.Ccdm.002	The CCM function shall support the capability to verify the integrity and authenticity of the CIS cluster descriptor.	No
Ccm.Ccdm.003	The CCM function shall support the capability to verify that all mandatory information in the CIS cluster descriptor is present and complies with the standard for this information.	No
Ccm.Ccdm.004	The CCM function shall support the capability to notify about the result of management operations and changes of CIS cluster descriptors.	No

**Table A.2.3-4: Comparison of CIS cluster fault, performance and capacity management functional requirements and Terraform**

Numbering	Functional requirements description	Support by open source
Ccm.Cisassu.001	The CCM function shall support the capability to monitor the resources capacity in the CIS cluster and issue notifications related to capacity events and information.	No
Ccm.Cisassu.002	The CCM function shall support the capability to monitor for faults in the CIS cluster, and issue notifications and provide information related to alarms and fault events.	No
Ccm.Cisassu.003	The CCM function shall support the capability to monitor the performance of the CIS cluster, and issue notifications and provide information related to performance.	No
Ccm.Cisassu.004	The CCM function shall support the capability for a consumer to subscribe to notifications related to capacity, performance and fault events.	No

**Table A.2.3-5: comparison of CIS cluster lifecycle management functional requirements and Terraform**

Numbering	Functional requirements description	Support by open source
Ccm.Cislcm.001	The CCM function shall support the capability to create a CIS cluster.	Yes
Ccm.Cislcm.002	The CCM function shall support the capability to provide information about a CIS cluster and its CIS cluster nodes.	Yes
Ccm.Cislcm.003	The CCM function shall support the capability to modify a CIS cluster.	Yes
Ccm.Cislcm.004	The CCM function shall support the capability to delete a CIS cluster.	Yes
Ccm.Cislcm.005	The CCM function shall support the capability to notify on events related to changes to a CIS cluster and its CIS cluster nodes.	No

**Table A.2.3-6: comparison of CIS MCCO management requirements and Terraform**

Numbering	Functional requirements description	Support by open source
Ccm.Mccom.001	The CCM function shall support the capability to install (apply) an MCCO to the CIS cluster.	Yes
Ccm.Mccom.002	The CCM function shall support the capability to delete an MCCO from the CIS cluster.	Yes
Ccm.Mccom.003	The CCM function shall support the capability to modify an MCCO installed (applied) in a CIS cluster.	Yes
Ccm.Mccom.004	The CCM function shall support the capability to inventory the MCCOs installed (applied) in a CIS cluster.	Yes
Ccm.Mccom.005	The CCM function shall support the capability to provide information about the MCCOs that have been inventoried.	Yes
Ccm.Mccom.006	The CCM function shall support the capability to process the information about resource requirements from the MCCO declarative descriptor for performing the necessary resources management for the MCCO.	Yes

## A.3 Kubespray

### A.3.1 Overview

This clause analyses comparison of CCM requirements (including CCM service interface requirements specified in ETSI GS NFV-IFA 036 [1] and CCM functional requirements specified in ETSI GS NFV-IFA 010 [i.4]), and open source solution Kubespray.

Kubespray is a Kubernetes® sub-project contributed by K8s® SIG (Special Interest Group) aiming to provide a tool for installing/upgrading a Kubernetes® cluster that can be hosted on different infrastructure. It is a composition of Ansible™ playbooks, inventory, provisioning tools for Kubernetes® clusters configuration management.

### A.3.2 Comparison of CCM service interface requirements and Kubespray capabilities

This clause shows comparison of CCM service interface requirements defined in clause 5.1 of ETSI GS NFV-IFA 036 [1] as "Identifier" column and "Requirement" column from Table A.3.2-1 to Table A.3.2-6 and Kubespray as "Support by open source" and "Related capability of open source" column. The legend of "Support by open source" are following:

- "Yes": fully support the CCM service requirements.
- "No": not support the CCM service requirements.
- "Partial": partial support the CCM service requirements.

**Table A.3.2-1: Comparison of CCM service requirements and Kubespray**

Identifier	Requirement	Support by open source	Related capability of open source
CcmSvc.001	The CCM shall provide a CIS cluster lifecycle management service.	Partly	With Kubespray tool and related Ansible™ playbooks
CcmSvc.002	The CCM shall provide a CIS cluster fault management service.	No	
CcmSvc.003	The CCM shall provide a CIS cluster configuration management service.	Yes	With Kubespray tool and related Ansible™ playbooks
CcmSvc.004	The CCM shall provide a CIS cluster performance management service.	No	
CcmSvc.005	The CCM shall provide a CIS cluster security management service.	Yes	Using K8s® mechanism for security assurance
CcmSvc.006	The services provided by the CCM shall support access control (e.g. RBAC).	Yes	Using K8s® mechanism for access control

**Table A.3.2-2: Comparison of CIS cluster lifecycle management service interface requirements and Kubespray**

Identifier	Requirement	Support by open source	Related capability of open source
CcmCIMgt.001	The CIS cluster lifecycle management service interface produced by the CCM shall support creating a CIS cluster.	Yes	With Kubespray tool and related Ansible™ playbooks
CcmCIMgt.002	The CIS cluster lifecycle management service interface produced by the CCM shall support querying information about a CIS cluster.	No	
CcmCIMgt.003	The CIS cluster lifecycle management service interface produced by the CCM shall support modifying a CIS cluster.	Yes	With Kubespray tool and related Ansible™ playbooks
CcmCIMgt.004	The CIS cluster lifecycle management service interface produced by the CCM shall support deleting a CIS cluster.	Yes	With Kubespray tool and related Ansible™ playbooks
CcmCIMgt.005	The CIS cluster lifecycle management service interface produced by the CCM shall support sending notifications in the event of changes to a CIS cluster.	No	

**Table A.3.2-3: Comparison of CIS cluster fault management service interface requirements and Kubespray**

Identifier	Requirement	Support by open source	Related capability of open source
CcmFitMgt.001	The CIS cluster fault management service interface produced by the CCM shall enable its Consumers to collect CIS cluster fault information.	No	
CcmFitMgt.002	The CIS cluster fault management service interface produced by the CCM shall support sending notifications in event of a change in alarm information on a CIS cluster.	No	
CcmFitMgt.003	The CIS cluster fault management service interface produced by the CCM shall support sending notifications in event of the creation of an alarm on a CIS cluster.	No	
CcmFitMgt.004	The CIS cluster fault management service interface produced by the CCM shall support sending notifications in event of the clearance of an alarm on CIS cluster.	No	
CcmFitMgt.005	The CIS cluster fault management service interface produced by the CCM shall support acknowledgement of an alarm.	No	
CcmFitMgt.006	The CIS cluster fault management service interface produced by the CCM shall support sending notifications in event of rebuilt.	No	
CcmFitMgt.007	The CIS cluster fault management service interface produced by the CCM shall support managing subscriptions to the notifications related to alarms.	No	

**Table A.3.2-4: Comparison of CIS cluster configuration management service interface requirements and Kubespray**

Identifier	Requirement	Support by open source	Related capability of open source
CcmCfgMgt.001	The CIS cluster configuration management service interface produced by the CCM shall support transferring and applying CIS cluster configurations provided by the CCM Consumer.	Yes	With Kubespray tool and related Ansible™ playbooks
CcmCfgMgt.002	The CIS cluster configuration management service interface produced by the CCM shall support querying the information about CIS cluster configurations.	Yes	With Kubespray tool and related Ansible™ playbooks
CcmCfgMgt.003	The CIS cluster configuration management service interface produced by the CCM shall support sending notifications in the event of CIS cluster configuration changes.	No	
CcmCfgMgt.004	The CIS cluster configuration management service interface produced by the CCM shall support managing subscriptions to the notifications related to configuration management.	No	

**Table A.3.2-5: Comparison of CIS cluster performance management service interface requirements and Kubespray**

Identifier	Requirement	Support by open source	Related capability of open source
CcmPerfMgt.001	The CIS cluster performance management service interface produced by the CCM shall support controlling the collection and reporting of CIS cluster performance information, resulting from infrastructure resources (VMs or bare-metal servers) performance information, on the CIS cluster(s) it manages.	No	
CcmPerfMgt.002	The CIS cluster performance management service interface produced by the CCM shall support sending notifications in the event of the availability of CIS cluster performance information.	No	
CcmPerfMgt.003	The CIS cluster performance management service interface produced by the CCM shall support creating a PM job specifying the CIS cluster performance information to be collected.	No	
CcmPerfMgt.004	The CIS cluster performance management service interface produced by the CCM shall support deleting one or more PM job(s).	No	
CcmPerfMgt.005	The CIS cluster performance management service interface produced by the CCM shall support querying the information about one or more PM job(s).	No	
CcmPerfMgt.006	The CIS cluster performance management service interface produced by the CCM shall support managing the thresholds on specified CIS cluster performance information.	No	
CcmPerfMgt.007	The CIS cluster performance management service interface produced by the CCM shall support sending notifications in the event of a threshold defined for a specified metric of a CIS cluster being crossed.	No	
CcmPerfMgt.008	The CIS cluster performance management service interface produced by the CCM shall support managing subscriptions to the notifications related to performance management.	No	
CcmPerfMgt.009	The CIS cluster performance management service interface produced by the CCM shall support sending notifications in the event of shortage of capacity in the CIS cluster.	No	-

**Table A.3.2-6: Comparison of CIS cluster security management service interface requirements and Kubespray**

Identifier	Requirement	Support by open source	Related capability of open source
CcmSecMgt.001	The CIS cluster security management service interface produced by the CCM shall support configuration of security related information and artifacts for secure communication among CIS cluster nodes.	Yes	Using K8s <sup>®</sup> mechanism for security assurance
CcmSecMgt.002	The CIS cluster security management service interface produced by the CCM shall support configuration of authorization and authenticate invoking CISM capabilities from external and/or internal entities of the CIS cluster by using configuration files and declarative descriptors representing RBAC.	Yes	Using K8s <sup>®</sup> mechanism for access control
CcmSecMgt.003	The CIS cluster security management service interface produced by the CCM shall support configuration of auditing related information for auditing of CIS cluster nodes.	Yes	Using K8s <sup>®</sup> mechanism for auditing

### A.3.3 Comparison of CCM functional requirements and Kubespray capabilities

This clause shows comparison of CCM functional requirements defined in clause 5.1 of ETSI GS NFV-IFA 010 [i.4] as "Identifier" column and "Requirement" column from Table A.3.3-1 to Table A.3.3-5 and Kubespray as "Support by open source" column. The legend of "Support by open source" are following:

- "Yes": fully support the CCM service requirements.
- "No": not support the CCM service requirements.
- "Partial": partial support the CCM service requirements.

**Table A.3.3-1: Comparison of CIS cluster resource management functional requirements and Kubespray**

Numbering	Functional requirements description	Support by open source
Ccm.Ciscrm.001	In the case of VM-based CIS cluster, the CCM function shall support the capability to request compute, storage and network virtualised resource management from the VIM that fulfils the specified compute/storage/network resource requests and placement constraints for a CIS cluster.	Yes
Ccm.Ciscrm.002	In the case of bare-metal CIS cluster, the CCM function shall support the capability to request compute, storage and network resources management from corresponding physical resources infrastructure management that fulfils the specified compute/storage/network resource requests and placement constraints for a CIS cluster.	Yes
Ccm.Ciscrm.003	In the case of a CIS cluster to be deployed as one or more VNF, the CCM function shall support the capability to request NS lifecycle management from the NFVO that fulfils the specified VNF and NS requests and placement constraints for a CIS cluster.	No
Ccm.Ciscrm.004	The CCM function shall support the capability to manage the installation of network-related artefacts (e.g. executables or plugins) into the CIS cluster nodes to enable container cluster networking, i.e. primary and secondary container cluster networks.	Yes
Ccm.Ciscrm.005	The CCM function shall support the capability to process the information about resource requirements from the CIS cluster descriptor for performing the necessary resource management for the CIS cluster.	No
Ccm.Ciscrm.006	The CCM function shall support the capability to request an operation granting before executing the CIS cluster lifecycle operation procedure and whenever changes in usage of necessary physical and/or virtualised compute, storage and network resources is expected.	No, but this service is consumed by CCM, not produced by CCM



**Table A.3.3-2: Comparison of CIS cluster configuration management functional requirements and Kubespray**

Numbering	Functional requirements description	Support by open source
Ccm.Ciscfgm.001	The CCM function shall support the capability to configure the CIS cluster control plane endpoints with necessary IP and name resolution information.	Yes
Ccm.Ciscfgm.002	The CCM function shall support the capability to retrieve cluster-nodes network-related information about the CIS cluster nodes and configure the CIS cluster nodes with cluster nodes network-related configuration.	Yes
Ccm.Ciscfgm.003	The CCM function shall support the capability to request the CISM to apply corresponding network configuration for the primary container cluster network and secondary container cluster networks.	Yes
Ccm.Ciscfgm.004	The CCM function shall support the capability to configure the CISM with appropriate infrastructure provider controller information to enable the CISM to request the creation and setup of necessary network resources (e.g. external load balancer).	Yes
Ccm.Ciscfgm.005	The CCM function shall support the capability to configure the CISM with necessary configuration about access control.	Yes
Ccm.Ciscfgm.006	The CCM function shall support the capability to configure the CISM with provisioned storage resources for the CIS cluster.	Yes

**Table A.3.3-3: Comparison of CIS cluster descriptor management functional requirements and Kubespray**

Numbering	Functional requirements description	Support by open source
Ccm.Ccdm.001	The CCM function shall support the capability of management of CIS cluster descriptors.	Yes
Ccm.Ccdm.002	The CCM function shall support the capability to verify the integrity and authenticity of the CIS cluster descriptor.	No
Ccm.Ccdm.003	The CCM function shall support the capability to verify that all mandatory information in the CIS cluster descriptor is present and complies with the standard for this information.	No
Ccm.Ccdm.004	The CCM function shall support the capability to notify about the result of management operations and changes of CIS cluster descriptors.	Yes

**Table A.3.3-4: Comparison of CIS cluster fault, performance and capacity management functional requirements and Kubespray**

Numbering	Functional requirements description	Support by open source
Ccm.Cisassu.001	The CCM function shall support the capability to monitor the resources capacity in the CIS cluster and issue notifications related to capacity events and information.	No
Ccm.Cisassu.002	The CCM function shall support the capability to monitor for faults in the CIS cluster, and issue notifications and provide information related to alarms and fault events.	No
Ccm.Cisassu.003	The CCM function shall support the capability to monitor the performance of the CIS cluster, and issue notifications and provide information related to performance.	No
Ccm.Cisassu.004	The CCM function shall support the capability for a consumer to subscribe to notifications related to capacity, performance and fault events.	No

**Table A.3.3-5: comparison of CIS cluster lifecycle management functional requirements and Kubespray**

Numbering	Functional requirements description	Support by open source
Ccm.Cislcm.001	The CCM function shall support the capability to create a CIS cluster.	Yes
Ccm.Cislcm.002	The CCM function shall support the capability to provide information about a CIS cluster and its CIS cluster nodes.	No
Ccm.Cislcm.003	The CCM function shall support the capability to modify a CIS cluster.	Yes
Ccm.Cislcm.004	The CCM function shall support the capability to delete a CIS cluster.	Yes
Ccm.Cislcm.005	The CCM function shall support the capability to notify on events related to changes to a CIS cluster and its CIS cluster nodes.	No

**Table A.3.3-6: comparison of CIS MCCO management requirements and Kubespray**

Numbering	Functional requirements description	Support by open source
Ccm.Mccom.001	The CCM function shall support the capability to install (apply) an MCCO to the CIS cluster.	Yes
Ccm.Mccom.002	The CCM function shall support the capability to delete an MCCO from the CIS cluster.	Yes
Ccm.Mccom.003	The CCM function shall support the capability to modify an MCCO installed (applied) in a CIS cluster.	Yes
Ccm.Mccom.004	The CCM function shall support the capability to inventory the MCCOs installed (applied) in a CIS cluster.	No
Ccm.Mccom.005	The CCM function shall support the capability to provide information about the MCCOs that have been inventoried.	No
Ccm.Mccom.006	The CCM function shall support the capability to process the information about resource requirements from the MCCO declarative descriptor for performing the necessary resources management for the MCCO.	No

## A.4 Crossplane<sup>®</sup>

### A.4.1 Overview

This clause analyses comparison of CCM requirements (including CCM service interface requirements specified in ETSI GS NFV-IFA 036 [1] and CCM functional requirements specified in ETSI GS NFV-IFA 010 [i.4]), and open source solution Crossplane<sup>®</sup>.

Crossplane<sup>®</sup> is an open source Kubernetes<sup>®</sup> add-on project. Crossplane<sup>®</sup> aims to connect Kubernetes<sup>®</sup> cluster to external, non-Kubernetes<sup>®</sup> resources, and allows platform teams to build custom Kubernetes<sup>®</sup> APIs to consume those resources.

Crossplane<sup>®</sup> uses Kubernetes<sup>®</sup> Custom Resource Definitions (CRDs) to represent the external resources as native Kubernetes<sup>®</sup> objects.

Since Crossplane<sup>®</sup> is not designed for managing CIS clusters but for managing multiple non-Kubernetes<sup>®</sup> resource objects, the component definitions (such as Managed Resources and Composite Resources) in Crossplane<sup>®</sup> is universal for representing non-Kubernetes<sup>®</sup> resources but not specific for representing CIS cluster objects and CIS cluster node objects, which will make it difficult to profile certain Crossplane<sup>®</sup> APIs for certain CCM service interfaces.

## A.4.2 Comparison of CCM service interface requirements and Crossplane® capabilities

This clause shows comparison of CCM service interface requirements defined in clause 5.1 of ETSI GS NFV-IFA 036 [1] as "Identifier" column and "Requirement" column from Table A.4.2-1 to Table A.4.2-6 and Crossplane® as "Support by open source" and "Related capability of open source" column. The legend of "Support by open source" are following:

- "Yes": fully support the CCM service requirements.
- "No": not support the CCM service requirements.
- "Partial": partial support the CCM service requirements.

**Table A.4.2-1: Comparison of CCM service requirements and Crossplane®**

Identifier	Requirement	Support by open source	Related capability of open source
CcmSvc.001	The CCM shall provide a CIS cluster lifecycle management service.	Yes	No specific API for CIS cluster but a generic design for non-K8s® native objects. This problem is common wherever there is a Yes in corresponding "Support by open source" column for CIS cluster LCM and configuration mgmt
CcmSvc.002	The CCM shall provide a CIS cluster fault management service.	No	
CcmSvc.003	The CCM shall provide a CIS cluster configuration management service.	Yes	
CcmSvc.004	The CCM shall provide a CIS cluster performance management service.	No	
CcmSvc.005	The CCM shall provide a CIS cluster security management service.	Yes	Using K8s® mechanism for security assurance
CcmSvc.006	The services provided by the CCM shall support access control (e.g. RBAC).	Yes	Using K8s® mechanism for access control

**Table A.4.2-2: Comparison of CIS cluster lifecycle management service interface requirements and Crossplane®**

Identifier	Requirement	Support by open source	Related capability of open source
CcmCIMgt.001	The CIS cluster lifecycle management service interface produced by the CCM shall support creating a CIS cluster.	Yes	
CcmCIMgt.002	The CIS cluster lifecycle management service interface produced by the CCM shall support querying information about a CIS cluster.	Yes	
CcmCIMgt.003	The CIS cluster lifecycle management service interface produced by the CCM shall support modifying a CIS cluster.	Yes	
CcmCIMgt.004	The CIS cluster lifecycle management service interface produced by the CCM shall support deleting a CIS cluster.	Yes	
CcmCIMgt.005	The CIS cluster lifecycle management service interface produced by the CCM shall support sending notifications in the event of changes to a CIS cluster.	Yes	

**Table A.4.2-3: Comparison of CIS cluster fault management service interface requirements and Crossplane®**

Identifier	Requirement	Support by open source	Related capability of open source
CcmFitMgt.001	The CIS cluster fault management service interface produced by the CCM shall enable its Consumers to collect CIS cluster fault information.	No	
CcmFitMgt.002	The CIS cluster fault management service interface produced by the CCM shall support sending notifications in event of a change in alarm information on a CIS cluster.	No	
CcmFitMgt.003	The CIS cluster fault management service interface produced by the CCM shall support sending notifications in event of the creation of an alarm on a CIS cluster.	No	
CcmFitMgt.004	The CIS cluster fault management service interface produced by the CCM shall support sending notifications in event of the clearance of an alarm on CIS cluster.	No	
CcmFitMgt.005	The CIS cluster fault management service interface produced by the CCM shall support acknowledgement of an alarm.	No	
CcmFitMgt.006	The CIS cluster fault management service interface produced by the CCM shall support sending notifications in event of rebuilt.	No	
CcmFitMgt.007	The CIS cluster fault management service interface produced by the CCM shall support managing subscriptions to the notifications related to alarms.	No	

**Table A.4.2-4: Comparison of CIS cluster configuration management service interface requirements and Crossplane®**

Identifier	Requirement	Support by open source	Related capability of open source
CcmCfgMgt.001	The CIS cluster configuration management service interface produced by the CCM shall support transferring and applying CIS cluster configurations provided by the CCM Consumer.	Yes	
CcmCfgMgt.002	The CIS cluster configuration management service interface produced by the CCM shall support querying the information about CIS cluster configurations.	Yes	
CcmCfgMgt.003	The CIS cluster configuration management service interface produced by the CCM shall support sending notifications in the event of CIS cluster configuration changes.	Yes	
CcmCfgMgt.004	The CIS cluster configuration management service interface produced by the CCM shall support managing subscriptions to the notifications related to configuration management.	Yes	

**Table A.4.2-5: Comparison of CIS cluster performance management service interface requirements and Crossplane®**

Identifier	Requirement	Support by open source	Related capability of open source
CcmPerfMgt.001	The CIS cluster performance management service interface produced by the CCM shall support controlling the collection and reporting of CIS cluster performance information, resulting from infrastructure resources (VMs or bare-metal servers) performance information, on the CIS cluster(s) it manages.	No	
CcmPerfMgt.002	The CIS cluster performance management service interface produced by the CCM shall support sending notifications in the event of the availability of CIS cluster performance information.	No	
CcmPerfMgt.003	The CIS cluster performance management service interface produced by the CCM shall support creating a PM job specifying the CIS cluster performance information to be collected.	No	
CcmPerfMgt.004	The CIS cluster performance management service interface produced by the CCM shall support deleting one or more PM job(s).	No	
CcmPerfMgt.005	The CIS cluster performance management service interface produced by the CCM shall support querying the information about one or more PM job(s).	No	
CcmPerfMgt.006	The CIS cluster performance management service interface produced by the CCM shall support managing the thresholds on specified CIS cluster performance information.	No	
CcmPerfMgt.007	The CIS cluster performance management service interface produced by the CCM shall support sending notifications in the event of a threshold defined for a specified metric of a CIS cluster being crossed.	No	
CcmPerfMgt.008	The CIS cluster performance management service interface produced by the CCM shall support managing subscriptions to the notifications related to performance management.	No	
CcmPerfMgt.009	The CIS cluster performance management service interface produced by the CCM shall support sending notifications in the event of shortage of capacity in the CIS cluster.	No	

**Table A.4.2-6: Comparison of CIS cluster security management service interface requirements and Crossplane®**

Identifier	Requirement	Support by open source	Notes
CcmSecMgt.001	The CIS cluster security management service interface produced by the CCM shall support configuration of security related information and artifacts for secure communication among CIS cluster nodes.	Yes	Using K8s® mechanism for security assurance
CcmSecMgt.002	The CIS cluster security management service interface produced by the CCM shall support configuration of authorization and authenticate invoking CISM capabilities from external and/or internal entities of the CIS cluster by using configuration files and declarative descriptors representing RBAC.	Yes	Using K8s® mechanism for access control
CcmSecMgt.003	The CIS cluster security management service interface produced by the CCM shall support configuration of auditing related information for auditing of CIS cluster nodes.	Yes	Using K8s® mechanism for auditing

### A.4.3 Comparison of CCM functional requirements and Crossplane<sup>®</sup> capabilities

This clause shows comparison of CCM functional requirements defined in clause 5.1 of ETSI GS NFV-IFA 010 [i.4] as "Numbering" column and "Functional requirements description" column from Table A.4.3-1 to Table A.4.3-6 and Crossplane<sup>®</sup> as "Support by open source" column. The legend of "Support by open source" are following:

- "Yes": fully support the CCM service requirements.
- "No": not support the CCM service requirements.
- "Partial": partial support the CCM service requirements.

**Table A.4.3-1: Comparison of CIS cluster resource management functional requirements and Crossplane<sup>®</sup>**

Numbering	Functional requirements description	Support by open source
Ccm.Ciscrm.001	In the case of VM-based CIS cluster, the CCM function shall support the capability to request compute, storage and network virtualised resource management from the VIM that fulfils the specified compute/storage/network resource requests and placement constraints for a CIS cluster.	Yes
Ccm.Ciscrm.002	In the case of bare-metal CIS cluster, the CCM function shall support the capability to request compute, storage and network resources management from corresponding physical resources infrastructure management that fulfils the specified compute/storage/network resource requests and placement constraints for a CIS cluster.	Yes
Ccm.Ciscrm.003	In the case of a CIS cluster to be deployed as one or more VNF, the CCM function shall support the capability to request NS lifecycle management from the NFVO that fulfils the specified VNF and NS requests and placement constraints for a CIS cluster.	No
Ccm.Ciscrm.004	The CCM function shall support the capability to manage the installation of network-related artefacts (e.g. executables or plugins) into the CIS cluster nodes to enable container cluster networking, i.e. primary and secondary container cluster networks.	Partial, need to be supported by provider
Ccm.Ciscrm.005	The CCM function shall support the capability to process the information about resource requirements from the CIS cluster descriptor for performing the necessary resource management for the CIS cluster.	No
Ccm.Ciscrm.006	The CCM function shall support the capability to request an operation granting before executing the CIS cluster lifecycle operation procedure and whenever changes in usage of necessary physical and/or virtualised compute, storage and network resources is expected.	No, but this service is consumed by CCM, not produced by CCM

**Table A.4.3-2: Comparison of CIS cluster configuration management functional requirements and Crossplane®**

Numbering	Functional requirements description	Support by open source
Ccm.Ciscfgm.001	The CCM function shall support the capability to configure the CIS cluster control plane endpoints with necessary IP and name resolution information.	Yes
Ccm.Ciscfgm.002	The CCM function shall support the capability to retrieve cluster-nodes network-related information about the CIS cluster nodes and configure the CIS cluster nodes with cluster nodes network-related configuration.	Yes
Ccm.Ciscfgm.003	The CCM function shall support the capability to request the CISM to apply corresponding network configuration for the primary container cluster network and secondary container cluster networks.	Yes
Ccm.Ciscfgm.004	The CCM function shall support the capability to configure the CISM with appropriate infrastructure provider controller information to enable the CISM to request the creation and setup of necessary network resources (e.g. external load balancer).	Yes
Ccm.Ciscfgm.005	The CCM function shall support the capability to configure the CISM with necessary configuration about access control.	Yes
Ccm.Ciscfgm.006	The CCM function shall support the capability to configure the CISM with provisioned storage resources for the CIS cluster.	Yes

**Table A.4.3-3: Comparison of CIS cluster descriptor management functional requirements and Crossplane®**

Numbering	Functional requirements description	Support by open source
Ccm.Ccdm.001	The CCM function shall support the capability of management of CIS cluster descriptors.	Yes
Ccm.Ccdm.002	The CCM function shall support the capability to verify the integrity and authenticity of the CIS cluster descriptor.	No
Ccm.Ccdm.003	The CCM function shall support the capability to verify that all mandatory information in the CIS cluster descriptor is present and complies with the standard for this information.	No
Ccm.Ccdm.004	The CCM function shall support the capability to notify about the result of management operations and changes of CIS cluster descriptors.	Yes

**Table A.4.3-4: Comparison of CIS cluster fault, performance and capacity management functional requirements and Crossplane®**

Numbering	Functional requirements description	Support by open source
Ccm.Cisassu.001	The CCM function shall support the capability to monitor the resources capacity in the CIS cluster and issue notifications related to capacity events and information.	No
Ccm.Cisassu.002	The CCM function shall support the capability to monitor for faults in the CIS cluster, and issue notifications and provide information related to alarms and fault events.	No
Ccm.Cisassu.003	The CCM function shall support the capability to monitor the performance of the CIS cluster, and issue notifications and provide information related to performance.	No
Ccm.Cisassu.004	The CCM function shall support the capability for a consumer to subscribe to notifications related to capacity, performance and fault events.	No

**Table A.4.3-5: comparison of CIS cluster lifecycle management functional requirements and Crossplane®**

Numbering	Functional requirements description	Support by open source
Ccm.Cislcm.001	The CCM function shall support the capability to create a CIS cluster.	Yes
Ccm.Cislcm.002	The CCM function shall support the capability to provide information about a CIS cluster and its CIS cluster nodes.	Yes
Ccm.Cislcm.003	The CCM function shall support the capability to modify a CIS cluster.	Yes
Ccm.Cislcm.004	The CCM function shall support the capability to delete a CIS cluster.	Yes
Ccm.Cislcm.005	The CCM function shall support the capability to notify on events related to changes to a CIS cluster and its CIS cluster nodes.	Yes

**Table A.4.3-6: comparison of CIS MCCO management requirements and Crossplane®**

Numbering	Functional requirements description	Support by open source
Ccm.Mccom.001	The CCM function shall support the capability to install (apply) an MCCO to the CIS cluster.	Yes
Ccm.Mccom.002	The CCM function shall support the capability to delete an MCCO from the CIS cluster.	Yes
Ccm.Mccom.003	The CCM function shall support the capability to modify an MCCO installed (applied) in a CIS cluster.	Yes
Ccm.Mccom.004	The CCM function shall support the capability to inventory the MCCOs installed (applied) in a CIS cluster.	Yes
Ccm.Mccom.005	The CCM function shall support the capability to provide information about the MCCOs that have been inventoried.	Yes
Ccm.Mccom.006	The CCM function shall support the capability to process the information about resource requirements from the MCCO declarative descriptor for performing the necessary resources management for the MCCO.	Yes

## A.5 OpenStack® Tacker

### A.5.1 Overview

This clause analyses comparison of CCM requirements defined in ETSI GS NFV-IFA 036 [1] and OpenStack® Tacker. OpenStack® Tacker is an official OpenStack® project building a Generic VNF compliant with ETSI NFV ISG specification, and OpenStack® Tacker supports certain APIs of VNF Lifecycle Management interface, VNF Performance Management interface and VNF Fault Management interface specified in ETSI GS NFV-SOL 002 [i.2] and ETSI GS NFV-SOL 003 [i.3]. OpenStack® Tacker can create and manage a CIS cluster partially with leveraging these APIs.

NOTE 1: The OpenStack® Word Mark and OpenStack Logo are either registered trademarks/service marks or trademarks/service marks of the OpenStack Foundation, in the United States and other countries and are used with the OpenStack Foundation's permission. ETSI is not affiliated with, endorsed or sponsored by the OpenStack Foundation, or the OpenStack community.

In present document, this analysis based on the Antelope release of OpenStack® Tacker which did not implement in compliance with the CCM specification assumes that CCD is mapped to VNFD, CCND is mapped to VDU, and CCRD is mapped to VirtualComputeDesc and Virtual Resource Descriptor (HOT) in clause 6.4.3 of ETSI GS NFV-IFA 036 [1].

NOTE 2: Tacker is designed for building a Generic VNF Manager (VNFM) to deploy and operate VNFs on NFV infrastructure. Tacker uses ETSI GS NFV-SOL 003 [i.3] style API to achieve new capabilities for managing virtual CIS cluster in its latest release, and Tacker plans to provide CAPI-involved solution for managing bare-metal CIS cluster in future release.



## A.5.2 Comparison of CCM service interface requirements and OpenStack® Tacker capabilities

This clause shows comparison of CCM service requirements defined in clause 5.1 of ETSI GS NFV-IFA 036 [1] as "Identifier" column and "Requirement" column from Table A.5.2-1 to Table A.5.2-6 and OpenStack® Tacker as "Support by open source" and "Related capability of open source" from Table A.5.2-1 to Table A.5.2-6. The legend of "Support by open source" are following:

- "Yes": fully support the CCM service requirements.
- "No": not support the CCM service requirements.
- "Partial": partial support the CCM service requirements.

**Table A.5.2-1: comparison of CCM service requirements and OpenStack® Tacker**

Identifier	Requirement	Support by open source	Related capability of open source
CcmSvc.001	The CCM shall provide a CIS cluster lifecycle management service.	Yes	VNF LCM API
CcmSvc.002	The CCM shall provide a CIS cluster fault management service.	Yes	VNF FM API
CcmSvc.003	The CCM shall provide a CIS cluster configuration management service.	Yes	VNF LCM API
CcmSvc.004	The CCM shall provide a CIS cluster performance management service.	Yes	VNF PM API
CcmSvc.005	The CCM shall provide a CIS cluster security management service.	No	-
CcmSvc.006	The services provided by the CCM shall support access control (e.g. RBAC).	Partial	Tacker supports OAuth with Keystone.

**Table A.5.2-2: comparison of CIS Cluster management requirements and OpenStack® Tacker**

Identifier	Requirement	Support by open source	Related capability of open source
CcmCIMgt.001	The CIS cluster lifecycle management service interface produced by the CCM shall support creating a CIS cluster.	Yes	Instantiate a VNF instance
CcmCIMgt.002	The CIS cluster lifecycle management service interface produced by the CCM shall support querying information about a CIS cluster.	Yes	Show VNF instance
CcmCIMgt.003	The CIS cluster lifecycle management service interface produced by the CCM shall support modifying a CIS cluster.	Yes	Update a VNF instance
CcmCIMgt.004	The CIS cluster lifecycle management service interface produced by the CCM shall support deleting a CIS cluster.	Yes	Terminate a VNF instance
CcmCIMgt.005	The CIS cluster lifecycle management service interface produced by the CCM shall support sending notifications in the event of changes to a CIS cluster.	Yes	Notification endpoint

**Table A.5.2-3: comparison of CIS Cluster fault management requirements and OpenStack® Tacker**

Identifier	Requirement	Support by open source	Related capability of open source
CcmFitMgt.001	The CIS cluster fault management service interface produced by the CCM shall enable its Consumers to collect CIS cluster fault information.	Yes	Get all alarms
CcmFitMgt.002	The CIS cluster fault management service interface produced by the CCM shall support sending notifications in event of a change in alarm information on a CIS cluster.	Yes	Notify fault event
CcmFitMgt.003	The CIS cluster fault management service interface produced by the CCM shall support sending notifications in event of the creation of an alarm on a CIS cluster.	Yes	Notify fault event
CcmFitMgt.004	The CIS cluster fault management service interface produced by the CCM shall support sending notifications in event of the clearance of an alarm on CIS cluster.	Yes	Notify fault event
CcmFitMgt.005	The CIS cluster fault management service interface produced by the CCM shall support acknowledgement of an alarm.	Yes	Modify the confirmation status
CcmFitMgt.006	The CIS cluster fault management service interface produced by the CCM shall support sending notifications in event of rebuilt.	No	-
CcmFitMgt.007	The CIS cluster fault management service interface produced by the CCM shall support managing subscriptions to the notifications related to alarms.	Yes	Create a subscription

**Table A.5.2-4: comparison of CIS Cluster configuration management requirements and OpenStack® Tacker**

Identifier	Requirement	Support by open source	Related capability of open source
CcmCfgMgt.001	The CIS cluster configuration management service interface produced by the CCM shall support transferring and applying CIS cluster configurations provided by the CCM Consumer.	Yes	Update a VNF instance
CcmCfgMgt.002	The CIS cluster configuration management service interface produced by the CCM shall support querying the information about CIS cluster configurations.	Yes	Show VNF instance
CcmCfgMgt.003	The CIS cluster configuration management service interface produced by the CCM shall support sending notifications in the event of CIS cluster configuration changes.	No	-
CcmCfgMgt.004	The CIS cluster configuration management service interface produced by the CCM shall support managing subscriptions to the notifications related to configuration management.	No	-

**Table A.5.2-5: comparison of CIS Cluster performance management requirements and OpenStack® Tacker**

Identifier	Requirement	Support by open source	Related capability of open source
CcmPerfMgt.001	The CIS cluster performance management service interface produced by the CCM shall support controlling the collection and reporting of CIS cluster performance information, resulting from infrastructure resources (VMs or bare-metal servers) performance information, on the CIS cluster(s) it manages.	Yes	Create a PM job Get for PM jobs
CcmPerfMgt.002	The CIS cluster performance management service interface produced by the CCM shall support sending notifications in the event of the availability of CIS cluster performance information.	Partial	
CcmPerfMgt.003	The CIS cluster performance management service interface produced by the CCM shall support creating a PM job specifying the CIS cluster performance information to be collected.	Yes	Create a PM job
CcmPerfMgt.004	The CIS cluster performance management service interface produced by the CCM shall support deleting one or more PM job(s).	Yes	Delete a PM job
CcmPerfMgt.005	The CIS cluster performance management service interface produced by the CCM shall support querying the information about one or more PM job(s).	Yes	Get for PM jobs
CcmPerfMgt.006	The CIS cluster performance management service interface produced by the CCM shall support managing the thresholds on specified CIS cluster performance information.	No	-
CcmPerfMgt.007	The CIS cluster performance management service interface produced by the CCM shall support sending notifications in the event of a threshold defined for a specified metric of a CIS cluster being crossed.	No	-
CcmPerfMgt.008	The CIS cluster performance management service interface produced by the CCM shall support managing subscriptions to the notifications related to performance management.	Yes	Create a subscription
CcmPerfMgt.009	The CIS cluster performance management service interface produced by the CCM shall support sending notifications in the event of shortage of capacity in the CIS cluster.	No	-

**Table A.5.2-6: comparison of CIS Cluster security management requirements and OpenStack® Tacker**

Identifier	Requirement	Support by open source	Related capability of open source
CcmSecMgt.001	The CIS cluster security management service interface produced by the CCM shall support configuration of security related information and artifacts for secure communication among CIS cluster nodes.	No	-
CcmSecMgt.002	The CIS cluster security management service interface produced by the CCM shall support configuration of authorization and authenticate invoking CISM capabilities from external and/or internal entities of the CIS cluster by using configuration files and declarative descriptors representing RBAC.	Partial	Tacker supports OAuth with Keystone
CcmSecMgt.003	The CIS cluster security management service interface produced by the CCM shall support configuration of auditing related information for auditing of CIS cluster nodes.	No	-

### A.5.3 Comparison of CCM functional requirements and OpenStack® Tacker capabilities

This clause shows comparison of CCM functional requirements defined in clause 14 of ETSI GS NFV-IFA 010 [i.4] as "Identifier" column and "Requirement" column from Table A.5.3-1 to Table A.5.3-6 and OpenStack® Tacker as "Support by open source" from Table A.5.3-1 to Table A.5.3-6. The legend of "Support by open source" are following:

- "Yes": fully support the CCM service requirements.
- "No": not support the CCM service requirements.
- "Partial": partial support the CCM service requirements.

**Table A.5.3-1: comparison of CIS Cluster resource management requirements and OpenStack® Tacker**

Numbering	Functional requirements description	Support by open source
Ccm.Ciscrm.001	In the case of VM-based CIS cluster, the CCM function shall support the capability to request compute, storage and network virtualised resource management from the VIM that fulfils the specified compute/storage/network resource requests and placement constraints for a CIS cluster.	Partial
Ccm.Ciscrm.002	In the case of bare-metal CIS cluster, the CCM function shall support the capability to request compute, storage and network resources management from corresponding physical resources infrastructure management that fulfils the specified compute/storage/network resource requests and placement constraints for a CIS cluster.	Partial
Ccm.Ciscrm.003	In the case of a CIS cluster to be deployed as one or more VNF, the CCM function shall support the capability to request NS lifecycle management from the NFVO that fulfils the specified VNF and NS requests and placement constraints for a CIS cluster.	No
Ccm.Ciscrm.004	The CCM function shall support the capability to manage the installation of network-related artefacts (e.g. executables or plugins) into the CIS cluster nodes to enable container cluster networking, i.e. primary and secondary container cluster networks.	No
Ccm.Ciscrm.005	The CCM function shall support the capability to process the information about resource requirements from the CIS cluster descriptor for performing the necessary resource management for the CIS cluster.	Partial
Ccm.Ciscrm.006	The CCM function shall support the capability to request an operation granting before executing the CIS cluster lifecycle operation procedure and whenever changes in usage of necessary physical and/or virtualised compute, storage and network resources is expected.	Yes

**Table A.5.3-2: comparison of CIS Cluster configuration management requirements and OpenStack® Tacker**

Numbering	Functional requirements description	Support by open source
Ccm.Ciscfgm.001	The CCM function shall support the capability to configure the CIS cluster control plane endpoints with necessary IP and name resolution information.	Partial
Ccm.Ciscfgm.002	The CCM function shall support the capability to retrieve cluster-nodes network-related information about the CIS cluster nodes and configure the CIS cluster nodes with cluster nodes network-related configuration.	Yes
Ccm.Ciscfgm.003	The CCM function shall support the capability to request the CISM to apply corresponding network configuration for the primary container cluster network and secondary container cluster networks.	Yes
Ccm.Ciscfgm.004	The CCM function shall support the capability to configure the CISM with appropriate infrastructure provider controller information to enable the CISM to request the creation and setup of necessary network resources (e.g. external load balancer).	Yes
Ccm.Ciscfgm.005	The CCM function shall support the capability to configure the CISM with necessary configuration about access control.	No
Ccm.Ciscfgm.006	The CCM function shall support the capability to configure the CISM with provisioned storage resources for the CIS cluster.	No

**Table A.5.3-3: comparison of CIS Cluster descriptor management requirements and OpenStack® Tacker**

Numbering	Functional requirements description	Support by open source
Ccm.Ccdm.001	The CCM function shall support the capability of management of CIS cluster descriptors.	Partial
Ccm.Ccdm.002	The CCM function shall support the capability to verify the integrity and authenticity of the CIS cluster descriptor.	No
Ccm.Ccdm.003	The CCM function shall support the capability to verify that all mandatory information in the CIS cluster descriptor is present and complies with the standard for this information.	No
Ccm.Ccdm.004	The CCM function shall support the capability to notify about the result of management operations and changes of CIS cluster descriptors.	No

**Table A.5.3-4: comparison of CIS Cluster fault, performance and capacity management requirements and OpenStack® Tacker**

Numbering	Functional requirements description	Support by open source
Ccm.Cisassu.001	The CCM function shall support the capability to monitor the resources capacity in the CIS cluster and issue notifications related to capacity events and information.	No
Ccm.Cisassu.002	The CCM function shall support the capability to monitor for faults in the CIS cluster, and issue notifications and provide information related to alarms and fault events.	Yes
Ccm.Cisassu.003	The CCM function shall support the capability to monitor the performance of the CIS cluster, and issue notifications and provide information related to performance.	Yes
Ccm.Cisassu.004	The CCM function shall support the capability for a consumer to subscribe to notifications related to capacity, performance and fault events.	Partial support to subscribe to notifications of performance and fault event, but not support to capacity.

**Table A.5.3-5: comparison of CIS Cluster lifecycle management requirements and OpenStack® Tacker**

Numbering	Functional requirements description	Support by open source
Ccm.Cislcm.001	The CCM function shall support the capability to create a CIS cluster.	Yes
Ccm.Cislcm.002	The CCM function shall support the capability to provide information about a CIS cluster and its CIS cluster nodes.	Yes
Ccm.Cislcm.003	The CCM function shall support the capability to modify a CIS cluster.	Yes
Ccm.Cislcm.004	The CCM function shall support the capability to delete a CIS cluster.	Yes
Ccm.Cislcm.005	The CCM function shall support the capability to notify on events related to changes to a CIS cluster and its CIS cluster nodes.	Yes

**Table A.5.3-6: comparison of CIS MCCO management requirements and OpenStack® Tacker**

Numbering	Functional requirements description	Support by open source
Ccm.Mccom.001	The CCM function shall support the capability to install (apply) an MCCO to the CIS cluster.	No
Ccm.Mccom.002	The CCM function shall support the capability to delete an MCCO from the CIS cluster.	No
Ccm.Mccom.003	The CCM function shall support the capability to modify an MCCO installed (applied) in a CIS cluster.	No
Ccm.Mccom.004	The CCM function shall support the capability to inventory the MCCOs installed (applied) in a CIS cluster.	No
Ccm.Mccom.005	The CCM function shall support the capability to provide information about the MCCOs that have been inventoried.	No
Ccm.Mccom.006	The CCM function shall support the capability to process the information about resource requirements from the MCCO declarative descriptor for performing the necessary resources management for the MCCO.	No

## A.5.4 Capabilities of Tacker to manage CIS cluster

### A.5.4.1 Introduction

OpenStack® Tacker partially supports CCM service requirements by reusing VNF LCM API as specified in [i.5], VNF FM API as specified in [i.7] and VNF PM API as specified in [i.6]. This clause explains OpenStack® Tacker architecture and how Tacker manages VM-based and bare-metal CIS clusters.

### A.5.4.2 OpenStack® Tacker architecture

Tacker consists of "tacker-server", "tacker-conductor" and "TackerDB" as illustrated in Figure A.5.4.2-1.

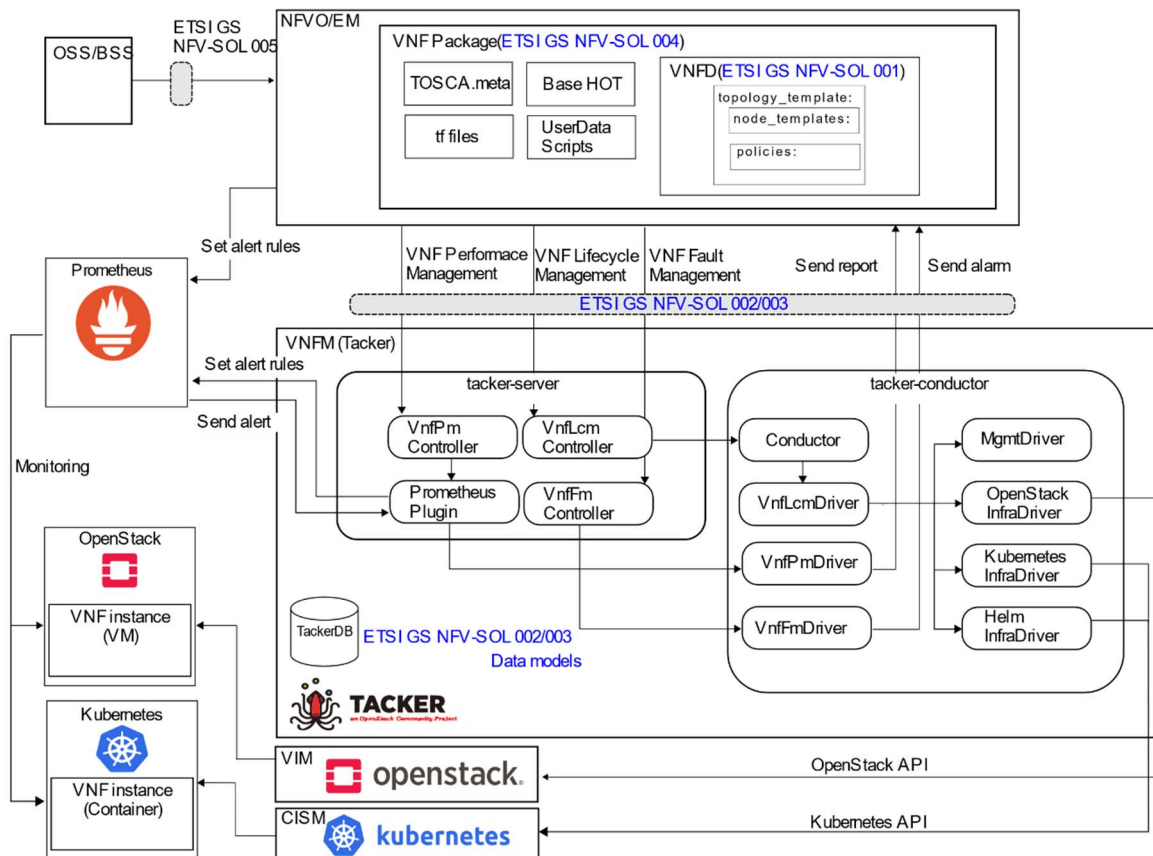

**Figure A.5.4.2-1: OpenStack® Tacker architecture**

The "tacker-server" includes several controllers to handle requests from NFVO via ETSI GS NFV-SOL 003 [i.3], from EM via ETSI GS NFV-SOL 002 [i.2], and from external monitoring tools such as Prometheus™ via de-facto standard interfaces. For instance, the "VnfPmController" component is responsible for retrieving PM job(s) information from the "TackerDB" and for providing requested information to NFVO as specified in clause 6.3.2-1 of ETSI GS NFV-SOL 003 [i.3].

The "tacker-conductor" implements all logics to operate VNF instances and includes three types of drivers:

- **InfraDrivers:**
  - Provides framework to manage virtualised resources or containerized workloads such as create VMs or pods.
  - Default InfraDrivers support Virtual Resource Descriptors [i.10] and Kubernetes®/Helm®.
  - Expected to be provided by the Infrastructure Provider.
- **MgmtDrivers:**
  - Provides framework to configure VNF instances.
  - Default MgmtDrivers support Ansible™ and shell scripts.
  - Expected to be provided/customized by the VNF Provider.
- **VnfLcm/VnfPm/VnfFmDrivers.**

The "TackerDB" is a database to hold any information such as VNFD, VNF Instance resource and VNF LCM operation occurrence resource.

More detailed information about Tacker architecture and components can be found in the Tacker user guide [i.9].

In order to manage virtual resource of VM based VNF and container based VNF, Tacker assumes following in Table A.5.4.2-1 as precondition and Tacker execute each VNF LCM operation as describe in Table A.5.4.2-2.

**Table A.5.4.2-1: OpenStack® Tacker capability to manage VM based VNF and container based VNF**

Aspect of VNF LCM	VM based VNF (e.g. OpenStack®)	Container based VNF (e.g. Kubernetes®/Helm®)
Virtual Resource	Compute (VM)	Pod (Container)
VIM/CISM API	OpenStack® HEAT API	Helm® API and k8sclient API
VNF Package	VNFD + Heat Template (HOT)	VNFD + Helm® chart
Scale level	max_scale_level in VNFD	Replicas

**Table A.5.4.2-2: mapping operation between VNF LCM operation and virtual resource mgmt**

VNF LCM operation	VM based VNF (e.g. OpenStack®)	Container based VNF (e.g. Kubernetes®/Helm®)
Instantiate VNF	Stack create	Helm® install
Scale VNF	Stack update	Helm® upgrade command, or Scale API (kubernetes® client)
Heal VNF	Stack delete and create	Delete Pod, then Kubernetes® creates new Pod
Terminate VNF	Stack delete	Helm® uninstall command
Change Current VNF Package	Stack update	Helm® upgrade command, or Patch API (kubernetes® client)

### A.5.4.3 Managing VM based CIS cluster

Tacker creates and delete VM based CIS cluster reusing VNF LCM API specified in ETSI GS NFV-SOL 002 [i.2] and ETSI GS NFV-SOL 003 [i.3] with OpenStack® based VIM. In this usecase, it is assumed that VNFD maps to CCD as described in clause 6.4.3 of ETSI GS NFV-IFA 036 [1], and Tacker assumes that CIS cluster provider who is provider of VNFD for CIS cluster as CCD provides mgmt-driver to manage and configure CIS cluster as a part of CCM, VNFD based Descriptor to manage CIS cluster as VM based VNF and Virtual Resource Descriptor (HOT) as described in Table A.5.4.2-1. For creating CIS cluster, Tacker receives request of Instantiate VNF operation to prepare virtual resource for CIS cluster, and allocates virtual resource by HOT, then Tacker calls mgmt-driver to create CIS cluster Node and configure CIS cluster as illustrated in Figure A.5.4.3-1.

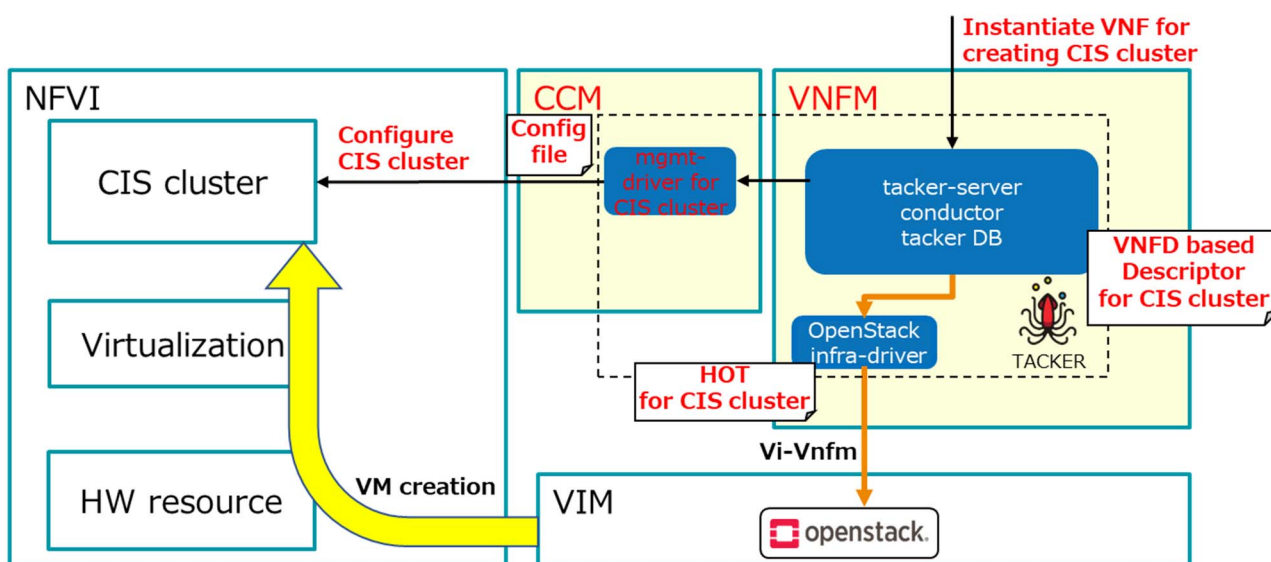

**Figure A.5.4.3-1: Creation of VM based CIS cluster by OpenStack® Tacker**



### A.5.4.4 Managing bare-metal CIS cluster

Tacker creates and delete bare-metal CIS cluster reusing VNF LCM API specified in ETSI GS NFV-SOL 002 [i.2] and ETSI GS NFV-SOL 003 [i.3] as indicated creating a CIS cluster in a similar way as the VNFM in clause B.2 of ETSI GS NFV-IFA 036 [1] with OpenStack® based VIM as indicated clause 4.2.5.3 of ETSI GS NFV-IFA 036 [1]. In this use case, Tacker assumes that CIS cluster provider who is provider of CCD provides infra-driver with config file to manage a pool of physical resources for bare-metal CIS cluster, VNFD based Descriptor to manage bare-metal CIS cluster and Virtual Resource Descriptor (HOT) as described in Table A.5.4.2-1. For creating CIS cluster, Tacker receives request of create CIS cluster operation based on Instantiate VNF operation as trigger of creating CIS cluster, and allocates physical resources by HOT, then Tacker manages CIS cluster by infra-driver for managing CIS cluster as illustrated in Figure A.5.4.4-1. The OpenStack® Tacker release referenced in this version of the present document does not support an open source bare-metal CIS cluster management capability.

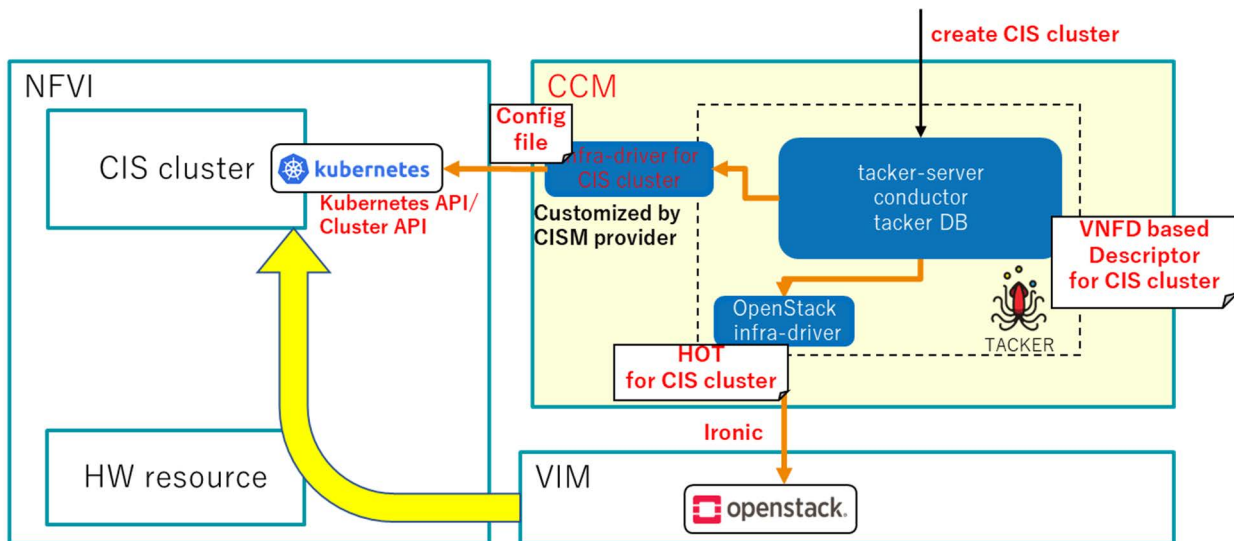

Figure A.5.4.4-1: Creation of bare-metal CIS cluster by OpenStack® Tacker

## A.6 Comparison of the open-source solutions against the CCM service interface requirements

Based on previous analysis on open-source solutions from annex A.1 to A.4, Table A.6-1 shows comparison of these open-source solutions (Kubernetes® Cluster API, Terraform, Kubespray and Crossplane®) against the CCM service interface requirements specified in ETSI GS NFV-IFA 036 [1]. Refer to "Requirement" column from Table A.1.2-1 to Table A.1.2-6 for the detailed CCM service interface requirement description related to each requirement identifier. The legend of "Support by open-source" are following:

- "Yes": fully support the CCM service requirements.
- "No": not support the CCM service requirements.
- "Partial": partial support the CCM service requirements.

**Table A.6-1: Comparison of the open-source solutions against the CCM service interface requirements**

Identifier	Support by Kubernetes® Cluster API	Support by Terraform	Support by Kubespray	Support by Crossplane®	Support by OpenStack® Tacker
CcmSvc.001	Yes	Yes	Partial	Yes	Yes
CcmSvc.002	Yes	No	No	No	Yes
CcmSvc.003	Yes	Yes	Yes	Yes	Yes
CcmSvc.004	Partial	No	No	No	Yes
CcmSvc.005	Yes	Yes	Yes	Yes	No
CcmSvc.006	Yes	Yes	Yes	Yes	Partial
CcmCIMgt.001	Yes	Yes	Yes	Yes	Yes
CcmCIMgt.002	Yes	Yes	No	Yes	Yes
CcmCIMgt.003	Yes	Yes	Yes	Yes	Yes
CcmCIMgt.004	Yes	Yes	Yes	Yes	Yes
CcmCIMgt.005	Yes	No	No	Yes	Yes
CcmFltMgt.001	Yes	No	No	No	Yes
CcmFltMgt.002	Yes	No	No	No	Yes
CcmFltMgt.003	Yes	No	No	No	Yes
CcmFltMgt.004	Yes	No	No	No	Yes
CcmFltMgt.005	Yes	No	No	No	Yes
CcmFltMgt.006	Yes	No	No	No	No
CcmFltMgt.007	Yes	No	No	No	Yes
CcmCfgMgt.001	Yes	Yes	Yes	Yes	Yes
CcmCfgMgt.002	Yes	Yes	Yes	Yes	Yes
CcmCfgMgt.003	Yes	No	No	Yes	No
CcmCfgMgt.004	Yes	No	No	Yes	No
CcmPerfMgt.001	Partial	No	No	No	Yes
CcmPerfMgt.002	Partial	No	No	No	Partial
CcmPerfMgt.003	Partial	No	No	No	Yes
CcmPerfMgt.004	Partial	No	No	No	Yes
CcmPerfMgt.005	Partial	No	No	No	Yes
CcmPerfMgt.006	Partial	No	No	No	No
CcmPerfMgt.007	Partial	No	No	No	No
CcmPerfMgt.008	Partial	No	No	No	Yes
CcmPerfMgt.009	Partial	No	No	No	No
CcmSecMgt.001	Yes Yes Yes	Yes	Yes	Yes	No TBD No
CcmSecMgt.002	Yes	Yes	Yes	Yes	Partial
CcmSecMgt.003	Yes	Yes	Yes	Yes	No

Based on this comparison, among open-source solution candidates Kubernetes® Cluster API, Terraform, Kubespray and Crossplane®, Kubernetes® Cluster API is the most suitable one to meet the CCM service interface requirements.

Besides that, Tacker, a Generic VNF Manager (VNFM), uses SOL003 style API to achieve new capabilities for managing virtual CIS cluster in its latest release. CCD could be mapped to VNFD in ETSI GS NFV-IFA 036 [1], clause 6.4.3, and Tacker also maps CCD to VNFD. But there is an architectural difference between ETSI GS NFV-IFA 036 [1] and Tacker. The Tacker approach analysed here is based on the assumption that CCM exposes a SOL003-like interface as NBI. Clause 6.4.3 in ETSI GS NFV-IFA 036 [1] assumes that when creating the CIS cluster, CCM sends an instantiate NS request to the NFVO, i.e. CCM is a consumer of the NS LCM interface.

## A.7 Comparison of the open-source solutions against the CCM functional requirements

Based on previous analysis on open-source solutions from clauses A.1 to A.4, Table A.7-1 shows comparison of these open-source solutions (Kubernetes® Cluster API, Terraform, Kubespray and Crossplane®) against the CCM functional requirements specified in ETSI GS NFV-IFA 010 [i.4]. Refer to "Requirement" column from Table A.1.3-1 to Table A.1.3-5 for the detailed CCM functional requirement description related to each requirement identifier. The legend of "Support by open-source" are following:

- "Yes": fully support the CCM functional requirements.
- "No": not support the CCM functional requirements.
- "Partial": partial support the CCM functional requirements.

**Table A.7-1: Comparison of the open-source solutions against the CCM functional requirements**

Identifier	Support by Kubernetes® Cluster API	Support by Terraform	Support by Kubespray	Support by Crossplane®	Support by OpenStack® Tacker
Ccm.Ciscrm.001	Yes	Yes	Yes	Yes	Partial
Ccm.Ciscrm.002	Yes	Partial	Yes	Yes	Partial
Ccm.Ciscrm.003	No (see note 1)	No (see note 1)	No (see note 1)	No (see note 1)	No
Ccm.Ciscrm.004	Yes	Yes	Yes	Partial	No
Ccm.Ciscrm.005	Yes	No	No	No	Partial
Ccm.Ciscrm.006	No (see note 2)	No (see note 2)	No (see note 2)	No (see note 2)	Yes
Ccm.Ciscfgm.001	Yes	Yes	Yes	Yes	Partial
Ccm.Ciscfgm.002	Yes	Yes	Yes	Yes	Yes
Ccm.Ciscfgm.003	Yes	Yes	Yes	Yes	Yes
Ccm.Ciscfgm.004	Yes	Yes	Yes	Yes	Yes
Ccm.Ciscfgm.005	Yes	Yes	Yes	Yes	No
Ccm.Ciscfgm.006	Yes	Yes	Yes	Yes	No
Ccm.Ccdm.001	Yes	No	Yes	Yes	Partial
Ccm.Ccdm.002	No (see note 3)	No (see note 3)	No (see note 3)	No (see note 3)	No
Ccm.Ccdm.003	No (see note 3)	No (see note 3)	No (see note 3)	No (see note 3)	No
Ccm.Ccdm.004	Yes	No	Yes	Yes	No
Ccm.Cisassu.001	Partial	No	No	No	No
Ccm.Cisassu.002	Yes	No	No	No	Yes
Ccm.Cisassu.003	Partial	No	No	No	Yes
Ccm.Cisassu.004	Yes	No	No	No	Partial
Ccm.Cislcm.001	Yes	Yes	Yes	Yes	Yes
Ccm.Cislcm.002	Yes	Yes	No	Yes	Yes
Ccm.Cislcm.003	Yes	Yes	Yes	Yes	Yes
Ccm.Cislcm.004	Yes	Yes	Yes	Yes	Yes
Ccm.Cislcm.005	Yes	No	No	Yes	Yes
Ccm.Mccom.001	Yes	Yes	Yes	Yes	No
Ccm.Mccom.002	Yes	Yes	Yes	Yes	No
Ccm.Mccom.003	Yes	Yes	Yes	Yes	No
Ccm.Mccom.004	Yes	Yes	No	Yes	No
Ccm.Mccom.005	Yes	Yes	No	Yes	No
Ccm.Mccom.006	Yes	Yes	No	Yes	No

NOTE 1: Description of Ccm.Ciscrm.003 is "In the case of a CIS cluster to be deployed as one or more VNF, the CCM function shall support the capability to request NS lifecycle management from the NFVO that fulfils the specified VNF and NS requests and placement constraints for a CIS cluster." All of these open-source solutions are for the case "manage a CIS cluster not as a NS", they don't apply this case "manage a CIS cluster as a NS". Therefore, there are all "No" in related "Support by open-source" cells in this row.

NOTE 2: Description of Ccm.Ciscrm.006 is "The CCM function shall support the capability to request an operation granting before executing the CIS cluster lifecycle operation procedure and whenever changes in usage of necessary physical and/or virtualised compute, storage and network resources is expected." This service is consumed by CCM and produced by NFVO, it is not produced by CCM. None of these open-source solutions can provide this granting capability (with interaction against NFVO) by itself. Therefore, there are all "No" in related "Support by open-source" cells in this row.

NOTE 3: Description of Ccm.Ccdm.002 is "The CCM function shall support the capability to verify the integrity and authenticity of the CIS cluster descriptor.". Description of Ccm.Ccdm.003 is "The CCM function shall support the capability to verify that all mandatory information in the CIS cluster descriptor is present and complies with the standard for this information." Since the CIS cluster descriptor is not specified yet, none of these two requirements could be met now (Specifying CIS cluster related descriptors is also out of the present document item's scope). Therefore, there are all "No" in related "Support by open-source" cells in these two rows.

Based on this comparison, among open-source solution candidates Kubernetes® Cluster API, Terraform, Kubespray and Crossplane®, Kubernetes® Cluster API is the most suitable one to meet the CCM functional requirements.

Besides that, for further information on Tacker in this comparison, refer to the architectural difference between CCM stage 2 and Tacker implementation mentioned in clause A.6.

Based on analysis in clauses A.6 and A.7, the majority CCM requirements could be met by profiling the most suitable open-source solution CAPI. The gap remaining is about the CIS cluster performance management and the granting operation consumed by CCM and produced by NFVO.

---

## Annex B (informative): The version supporting relationship between Cluster API and Kubernetes®

According to the Cluster API online document [2], a Cluster API minor release supports:

- 4 Kubernetes® minor releases for the management cluster (N to N-3, see note).
- 6 Kubernetes® minor releases for the workload cluster (N to N-5, see note).

NOTE: Kubernetes® minor release N is the latest published Kubernetes® minor release at the timepoint when a Cluster API minor release is initially published.

EXAMPLE: Cluster API minor release v1.5 (initially published in July 2023) supports the following Kubernetes® versions:

- Kubernetes® v1.24 to v1.27 for the management cluster.
- Kubernetes® v1.22 to v1.27 for the workload cluster.

## Annex C (informative): Change History

Date	Version	Information about changes
February 2023	0.0.1	First version providing the document skeleton and scope.
March 2023	0.0.2	Implemented approved contributions: NFVSOL(23)000070r1 - SOL020 clause 4.1 Summary of ETSI GS NFV-IFA036, NFVSOL(23)000079r2 - SOL020 Comparison of CCM and Kubernetes Cluster API, NFVSOL(23)000080 - SOL020 Comparison of CCM and Terraform, NFVSOL(23)000081 - SOL020 Comparison of CCM and Kubespray, NFVSOL(23)000082r1 - SOL020 Comparison of CCM and Crossplane, NFVSOL(23)000112 - SOL020 editorial unifying format for comparison of CCM and open-source solutions (CAPI), NFVSOL(23)000113 - SOL020 editorial unifying format for comparison of CCM and open-source solutions (Terraform), NFVSOL(23)000114r1 - SOL020 editorial unifying format for comparison of CCM and open-source solutions (Kubespray), NFVSOL(23)000115 - SOL020 editorial unifying format for comparison of CCM and open-source solutions (Crossplane).
June 2023	0.0.3	Implemented approved contributions: NFVSOL(23)000131r1 - SOL020 comparison of open-source solutions, NFVSOL(23)000068r5 - SOL020 Comparison of CCM and OpenStack Tacker, NFVSOL(23)000184 - SOL020 Editorial clean-up based on NFVSOL(23)000068r5, NFVSOL(23)000185 - SOL020 Add a comparison table of CIS MCCO mgmt. requirements and open-sources, NFVSOL(23)000186r1 - SOL020 Add Tacker column into comparison of open-source solutions table.
July 2023	0.0.4	Implemented approved contributions: NFVSOL(23)000201r1 - SOL020 clause 4.2 profiled protocol and data model solutions, NFVSOL(23)000211r1 - SOL020 clause 5 NFV object models mapping to profiled solution objects, NFVSOL(23)000219r1 - SOL020 skeleton of clause 6 CIS cluster LCM service interface, NFVSOL(23)000224 - SOL020 clause 6.4 cluster LCM sequence diagram #1 Creation, NFVSOL(23)000225 - SOL020 clause 6.5 cluster LCM resources, NFVSOL(23)000226 - SOL020 clause 6.4 cluster LCM sequence diagram #2 Querying, NFVSOL(23)000227 - SOL020 clause 6.4 cluster LCM sequence diagram #3 Modification, NFVSOL(23)000228 - SOL020 clause 6.4 cluster LCM sequence diagram #4 Deleting. Adding titles for all approved contributions in Annex B Change History.
September 2023	0.0.5	Implemented approved contributions: NFVSOL(23)000242 - SOL020 clause 7 CIS cluster configuration mgmt service interface, NFVSOL(23)000246 - SOL020 clause 9 CIS cluster fault mgmt. service interface, NFVSOL(23)000259 - SOL020 clause 7 configuration mgmt: ClusterResourceSetBinding, NFVSOL(23)000260r1 - SOL020 clause 10 CIS cluster security mgmt service interface, NFVSOL(23)000261 - SOL020 clause 6 cluster LCM service interface: MachinePool, NFVSOL(23)000262r1 - SOL020 Annex CAPI-K8s version supporting relationship, NFVSOL(23)000277 - SOL020 update on Cluster API minor release version
September 2023	0.1.0	Implemented approved contributions: NFVSOL(23)000306 - SOL020 Resolving Editors Notes part 1, NFVSOL(23)000307r2 - SOL020 Resolving Editors Notes part 2, NFVSOL(23)000312 - SOL020 Resolving ENs/TBDs in Annex A.5 NFVSOL(23)000321r1 - SOL020 Resolving Editors Notes part 4 and Editorial clean-ups
November 2023	0.2.0	Implemented approved contribution: NFVSOL(23)000367r1 - SOL020 Fix Tacker architecture figure in clause A 5.4.2
December 2023	V4.5.1	First published version

---

## History

<b>Document history</b>		
V4.5.1	December 2023	Publication